

Table of Contents

Rule 1.0	Administration.....	2
Rule 2.0	Membership.....	11
Rule 3.0	Racing Classes and Structures	14
Rule 4.0	Racing Fuel.	17
Rule 5.0	Water Safety.....	19
Rule 6.0	Points Championship Series.....	22
Rule 7.0	Competition Rules.....	26
Rule 8.0	Boat Safety Equipment-General	57
Rule 9.0	Drivers Safety Equipment-General	68
Rule 10.0	Capsule Boat Safety Equipment.....	71
Appendix A	Definitions and Terms	80
Appendix B	Member Associations	84
Appendix C	Fees and Fines	85
Appendix D	Sportsman and Division Championship.....	86
Appendix F	Capsule Latch Specs.....	89
Appendix G	Rudder Clamshell Specs.....	90
Appendix H	Windshield Attach Specs	92
Appendix I	Capsule Alignment Pins.....	93
Appendix J	SFI Specs & Recert. Reports.....	94
Index	95

RULE 1.0

ADMINISTRATION

1.1 Foreword

This rule book has been compiled and published by the KENTUCKY DRAG BOAT ASSOCIATION, with the express purpose of making clear the standards that must be met in order to conduct or participate in a sanctioned drag boat race. The rules, regulations, and safety requirements contained herein have been adopted from the member sanctioning bodies/divisions as listed in Appendix B.

Each member, participant, sponsor, promoter, potential member, potential participant, potential sponsor, or potential promoter is strongly encouraged to contact his local sanctioning body, division or chapter in order to obtain a rule book as well as any release forms which may be required to be signed prior to entry, sponsorship, or promotion of any sanctioned event. This should be done well in advance of the first sanctioned event in order that ample time is allowed to thoroughly read the rule book and release forms, and to review them with an attorney if necessary. Refer requests to the appropriate address as found in Appendix B.

1.2 Disclaimer

The rules and regulations set forth herein are designed to provide for the orderly conduct of racing events and to establish minimum acceptable requirements for such events. These rules shall govern the condition of all events, and by participating in these events, all participants are deemed to have complied with these rules. NO EXPRESS OR IMPLIED WARRANTY OF SAFETY SHALL RESULT FROM PUBLICATION OF OR COMPLIANCE WITH THESE RULES AND/OR REGULATIONS. They are intended as a guide for the conduct of the sport and are in no way a guarantee against injury or death to a participant, spectator, or official.

The sanctioning division or chapters Board of Directors, at any time, or its Sanction Supervisor/Competition Committee, during an event, shall be empowered to permit minor deviation from any of the specifications contained herein or impose any further restrictions that, in their opinion, do not alter the minimum acceptable requirements. NO EXPRESSED , OR IMPLIED WARRANTY OF SAFETY SHALL RESULT FROM SUCH ALTERATION OF SPECIFICATIONS. Any interpretation or deviation of these rules is left to the sole discretion of the sanctioning division or chapter's officials, acting in their capacity as agents of the sanctioning division or chapter, and their decision is final.

1.3 General Provisions

1 All annual racing members of the KENTUCKY DRAG BOAT ASSOCIATION, or any member division or chapter, together with all single event members and all associate members, as later referred to herein, by joining KENTUCKY DRAG BOAT ASSOCIATION, or said division or chapter, or by entering a single event, and all sponsors or promoters, as later referred to herein, by entering into an agreement or contract with KENTUCKY DRAG BOAT ASSOCIATION or said division or chapter to sponsor or promote a sanctioned event, agree and covenant to be bound by the rules, regulations, conditions, and other provisions contained herein this RACING RULES AND SAFETY REQUIREMENTS booklet. If any of the rules, regulations, conditions, or other provisions contained herein, or any parts thereof, are determined to be void or unenforceable, for whatever reason and by whatever authority, it is expressly understood and agreed by all annual racing members, single event members, associate members, sponsors, and promoters that the balance of the rules, regulations, conditions, and other provisions contained herein will remain enforceable. It is further understood and agreed that all annual racing members, single event members, associate members, sponsors, and promoters shall be solely responsible for obtaining and reviewing this RACING RULES AND SAFETY REQUIREMENTS booklet and understanding the contents of same prior to and during membership in the KENTUCKY DRAG BOAT ASSOCIATION, or any member division or chapter, or prior to and during the sponsorship or promotion of a sanctioned event. It is further understood and agreed that the rules, regulations, conditions and other provisions contained herein are not to be construed against KENTUCKY DRAG BOAT ASSOCIATION, its Directors, officers, officials, members, participants, agents, race track owners and/or operators, sponsors, promoters, or any other individual or entity, as well as any member division or chapter, their Directors, officers, officials, members, participants, agents, race track owners and/or operators, sponsors, promoters, or any other individual or entity, simply because KENTUCKY DRAG BOAT ASSOCIATION, or said division or chapter and its agents helped draft same. To the contrary, it is agreed that these rules, regulations, conditions, and other provisions contained herein shall be construed such as to give the most appropriate meaning and intent commensurate with safety and the orderly administration of the sanctioned events. It is further agreed and understood that a failure to enforce any rule, regulation, condition, or other provision of this booklet shall not constitute a waiver of same, but to the contrary, same may be enforced in any or all other relevant situations. Finally, it is agreed that the rules, 'regulations, conditions, and other provisions contained herein this RACING RULES AND SAFETY REQUIREMENTS booklet shall be binding upon the successors, assigns, heirs, legatees, devisees, beneficiaries, fiduciaries, and agents of each annual racing member, single event member, associate member, sponsor, and promoter.

1.4 Assumption of Risk

The participant agrees that by entering a sanctioned event, he acknowledges that the event site is safe and suitable for racing, and he further acknowledges that by participating in the event, he may suffer bodily injury or death, or loss or damage to property. The participant further acknowledges that he has voluntarily assumed the risk of such losses and waives any claims for such losses against the KENTUCKY DRAG BOAT ASSOCIATION as well as the sanctioning division or chapter, their Directors, officers, officials, other participants, event sponsors, event promoters, race track owners and/or operators, other event officials, other member divisions or chapters, their Directors and officers, together with all agents and designees, and discharges such persons from responsibility for such losses, and covenants not to sue such persons for such losses. All participants shall be required, as a condition of participation, to sign all required entry forms, including such releases as shall be required by the sanctioning division or chapter. For purposes of this rule book, the term participant shall include any person directly or indirectly associated with any vehicle or boat which has been permitted to enter a sanctioned event site for the purpose of competition, including, but not limited to owners, drivers, and crew members.

THE KENTUCKY DRAG BOAT ASSOCIATION AS WELL AS THE SANCTIONING DIVISION OR CHAPTER, MAKES NO REPRESENTATIONS, OR EXPRESS OR IMPLIED WARRANTIES, THAT COMPLIANCE WITH THE RULES AND REGULATIONS PUBLISHED IN THIS RULE BOOK, OR PUBLISHED DURING THE COURSE OF THE YEAR IN ANY OTHER PUBLICATION, WILL PREVENT OR GUARANTEE AGAINST INJURY OR DEATH TO PARTICIPANTS OR SPECTATORS OR DAMAGES TO PERSONAL PROPERTY. These rules and regulations constitute the minimum accepted standards for competition and are intended only as a guide for the conduct of the sport. Safety is the responsibility of equipment manufacturers, builders, and participants in the event.

Those participating in any sanctioned event, who elect to leave property at said event site(s) for themselves and/or on behalf of any and all owners of such property, release, waive, discharge, and covenant not to sue the KENTUCKY DRAG BOAT ASSOCIATION or the sanctioning division or chapter, their Directors, officers, officials, event sponsors, event promoters, race track owners and/or operators, employees, or representatives from and for all liability to the participant(s) and owners of the property, their fiduciaries, personal representatives, assigns, successors, heirs, legatees, devisees, next of kin, and all others for any and all loss or damage, and all claims or demands which may be made on account of loss or damage to any property of the participant or owner, or property of others entrusted to the participant or owner. This provision applies while the subject property is located at a sanctioned event site incidental to a sanctioned event.

1.5 Compliance of Rules

Each participant expressly agrees that by entering a sanctioned event, the participant agrees to be bound by all of the decisions, rules, and regulations of the KENTUCKY DRAG BOAT ASSOCIATION and the sanctioning division or chapter, including, but not limited to, all provisions and procedures provided for in this rule book, and by decisions, rules, and regulations which are applicable to a specific event. The participant agrees to be bound by and abide by the decisions of the sanctioning division or chapter's Board of Directors, Sanction Supervisor, Race Director, Competition Committee, or their designee, and other officials at all sanctioned events.

The participant, by entering a sanctioned event, also agrees that all decisions made during or incidental to an event are final and may not be appealed or made the basis of litigation. The participant further agrees to and does hereby release, discharge, acquit, and waive from liability the KENTUCKY DRAG BOAT ASSOCIATION, as well as the sanctioning division or chapter, their Directors, officers, officials, other participants, event sponsors, event promoters, race track owners and/or operators, all other event officials, other member divisions or chapters, their Directors and officers, together with all agents and designees, from any alleged or actual loss, claim, damage, or injury caused by decisions, erroneous or otherwise, or decisions based on malfunctioning electronic or mechanical equipment, whether due to negligent conduct or otherwise. The participant further agrees that any disputes concerning any event, the rules and regulations of the KENTUCKY DRAG BOAT ASSOCIATION, or the sanctioning division or chapter, or any decisions of the KENTUCKY DRAG BOAT ASSOCIATION. The sanctioning division or chapter, or their officials, whether or not incidental to an event, shall be resolved pursuant to the procedures provided for in this rule book. The participant agrees to indemnify and to hold harmless the KENTUCKY DRAG BOAT ASSOCIATION, as well as the sanctioning division or chapter and those other individuals and entities as released, for any litigation and non-litigation costs, attorney's fees, and other expenses incurred as a result of the failure of the participant or his/her agents to comply with the procedures and conditions provided for herein.

In order to ensure compliance with the rules and regulations established herein, the KENTUCKY DRAG BOAT ASSOCIATION, as well as the sanctioning division or chapter reserve the right to take action against any participant for failure to comply with any decision, rule, or regulation of the KY Drag Boat Association, as well as the sanctioning division or chapter reserve the right to take action against any participant for failure to comply with any decision, rule, or regulation of the Kentucky Drag Boat Association, or the sanctioning division or chapter. The action taken may include a suspension of a competitor's Competition Driver's License and/or membership, revocation of said driver's license and/or membership, suspension from any sanctioned event or events, expulsion from any sanctioned event or events, fines as provided for in Appendix C, public or private admonishments or reprimands, or any combination of the

aforementioned actions. The KENTUCKY DRAG BOAT ASSOCIATION, and the sanctioning division or chapter reserve the right to honor and reciprocally enforce any disciplinary action or other restrictions imposed by another drag boat racing association or promoter.

1.6 Waiver of Compliance

To race with the KENTUCKY DRAG BOAT ASSOCIATION, or any member division or chapter, all visiting racers from any association not utilizing this rule book must be in compliance with the rules and regulations of the sanctioning body with which they are licensed. This waiver does not pertain to capsule rules, breathing apparatus rules, or performance related criteria. These items will not be compromised and each participant must comply with all rules and regulations contained herein pertaining to these subjects in order to participate in any sanctioned event.

1.7 Substance Abuse Policy

No owner, driver, or crew member shall inhale, ingest, use, or partake of any alcoholic beverage, intoxicant, depressant, controlled drug or substance, or illegal drug or substance at any time immediately preceding or during any sanctioned event, unless prescribed by a medical doctor. Furthermore, while participating in a sanctioned event, no owner, driver, or crew member shall inhale, ingest, use, or partake of any prescription drug that could impair his ability to properly function in a racing atmosphere. If there is any suspicion with regard to the foregoing, the Sanction Supervisor may, at his discretion, require that the alleged offender submit to chemical analysis including, but not limited to, breath, blood, or urine tests. Such tests may be performed at the event site if there is a qualified medical doctor, EMT, or peace officer present to perform same. If requested, these tests may also be performed by any qualified medical personnel attending to a participant who has been involved in an accident. Any owner, driver, or crew member who registers for or enters any sanctioned event as a participant expressly consents to submit to such tests if requested by the Sanction Supervisor. Refusal to submit to such tests if requested, or testing positively, will result in the immediate disqualification of that participant's registered boat at that event. Further disciplinary action, such as future race suspensions, the revocation of one's Competition Driver's License, the loss of one's racing membership, or fines as indicated in Appendix C could result. Even if no chemical tests are performed, the Sanction Supervisor may, at his discretion, disqualify a participant if the Sanction Supervisor has a reasonable and strong belief that the participant is impaired and/or in violation of the Substance Abuse Policy. Each owner, driver, and crew member agree that, upon registering for any sanctioned event, he understands the foregoing policy and accepts the terms and conditions as outlined herein.

1.8 Advertising

The KENTUCKY DRAG BOAT ASSOCIATION, and the sanctioning division or chapter reserve the right to regulate by guideline, the advertising which appears on any boat participating in a sanctioned event and may from time to time publish such guidelines.

1.9 Publicity

In consideration of being allowed to promote and/or enter and by being issued entry passes, tickets, or credentials to a sanctioned event, all participants, sponsors, and promoters as well as anyone else using said entry passes, tickets, or credentials agree as follows:

1.9.1 All rights to advertising, promotion, filming, recording, exhibition, local and/or national television coverage, registered trademarks of the KENTUCKY DRAG BOAT ASSOCIATION, or sanctioning bodies, as well as any other exploitation of the event, the participants and boats entered in the event, and their activities at the site of the event before, during, and after the event, and reasonably related to the event, are reserved to the KENTUCKY DRAG BOAT ASSOCIATION, the sanctioning division or chapter, and their assigns.

1.9.2 The KENTUCKY DRAG BOAT ASSOCIATION, the sanctioning division or chapter, and their assigns are hereby granted (a) full and unconditional permission to make still or motion pictures and any other type(s) of audio or visual recordings of any participant and their boat's participation in the event and their activities at the site of the event before, during, and after the event, and reasonably related to the event; and (b) the exclusive, worldwide, and perpetual rights to use the same, together with their names, likeness, and biographies of participants, and the names, likeness, and date of, or relating to, the entered boat for publicity, advertising, exhibition, or exploitation, whether or not for profit, in print, audio, video, and other communications media by reproduction and sale or other distribution by any and all means now known or hereafter developed.

1.9.3 Without prior written consent of the KENTUCKY DRAG BOAT ASSOCIATION, or the sanctioning division or chapter, no one shall take any still or motion pictures or make any audio or visual recording of the event, participants therein, or activities at the site of the event for use other than personal, in-home use of the participant, or cause or permit others to do so or to use the same. The KENTUCKY DRAG BOAT ASSOCIATION, and the sanctioning division or chapter shall have exclusive, worldwide, perpetual, and universal use of any pictures or recordings made or used in violation of this paragraph, and the KENTUCKY DRAG BOAT ASSOCIATION, as well as the sanctioning division or chapter, shall be irreparably

harmd by the making or use of such pictures or recordings in such fashion without such permission.

1.10 Sale of Merchandise

1.10.1 Only the KENTUCKY DRAG BOAT ASSOCIATION, promoter, sanctioning body, or registered participants may offer merchandise for sale at a sanctioned event. All others must register with the promoter and/or sanctioning body and pay any applicable concessionaire fees. Registered participants may sell only T-shirts, tank tops, hats and such which depict said participant's boat or race team. No participant will be allowed to sell items for any other racer who is not registered at that event.

1.10.2 Some race sites/promoters may have additional requirements to sell merchandise at their event. It is the participants' responsibility to comply with any additional requirements.

1.11 Conduct & Action of Participants

The owner of any boat registered at a sanctioned event shall be directly responsible for not only his own conduct and actions, but he shall be held directly accountable for the conduct and actions of his driver(s) as well as each individual crew member. Misconduct, rude behavior, abusive language, deliberate disruption of the race program, actions detrimental to drag boat racing, or any other serious infraction of the rules and regulations contained herein by either the boat owner(s), driver(s), or individual crew member(s) could result in punishment including, but not limited to, verbal or written reprimand, disciplinary action, suspension, disqualification, revocation of membership, revocation of Competition Driver's License, loss of Points Championship Series points, or fines as indicated in Appendix C. Any participant or association official who initiates a physical confrontation and/or physically assaults another individual at a sanctioned event will automatically be suspended until further notice. The offender will be notified by the event Sanction Supervisor as to the disposition of the suspension. Any of the aforementioned actions by a crew member or driver will be binding upon any and all other driver(s) as well as any and all other owner(s) of said race boat.

1.11a Conduct expected of racers, crew and guests:

A. Boat owner is responsible for the conduct of crew and guest while those people are in the race course/pit areas or in the town where the event is staged during the days immediately before, during and immediately after the race.

B. The owner, driver, crew and guests are expected to obey the laws of the state and city and all rules of/or directions of the club or clubs putting the race on and those of the event sponsor (generally Lucas Oil).

C. The club or clubs have the authority to take punitive action by the club or clubs acting through their president or presidents to be appropriate when the aforementioned rules, regulations or laws are violated by any driver, crew or guest which may include loss of points or expulsion of the violator and or the team from the event wit.

D. It is the expectation that all participants conduct themselves in an orderly, sober and respectful manner so as not to reflect poorly on the club or clubs and the sponsors

1.12 Records & Rewards

1.12.1 Annual Membership. In order to establish and hold an official, divisional or national E.T. or M.P.H. record, all drivers of each boat must hold current fully paid annual racing memberships in the sanctioning division or chapter and comply with all rules and regulations set forth in this rule book. Memberships must be paid prior to setting any record. A single event member who sets what would otherwise have been either an E.T. or M.P.H. record will not be permitted to become

an annual racing member "after the fact" in order to claim the record.

1.12.2 Establishing a Record. Divisional records may be set at either divisional or national events; however, national records may only be set at national events. Both E.T. and M.P.H. records are maintained for each class. Any amount under the existing E.T. record or over the existing M.P.H. record shall qualify for a new record. The record run must be completed prior to the normal conclusion of racing activities during either qualifying or eliminations. Once eliminated, a boat will not be given an attempt at setting a new record.

1.12.3 Foul Start. A foul start will have no effect on a record run as far as establishing the record.

1.12.4 Multiple Records. If either the E.T. or M.P.H. record is set by more than one competitor during a single event, only the competitor achieving the lowest E.T. or the highest M.P.H. will be awarded the respective record.

1.12.5 Fuel/Oil/Water Samples. No record will be approved if the gasoline, alcohol, nitro-methane mixture, water (from the water injection system if so equipped), or engine lubricating oil is found to be illegal, or if no sample was obtained as the boat came out of the water after the record run. It is the driver's responsibility to stay on the ramp or the immediate vicinity thereof and get his fuel, oil, and water checked. A more detailed explanation can be found under "Racing Fuels/Fuel Samples."

1.12.6 Cubic Inch Check. All engines involved in setting a record are subject to a P&G check or an actual physical teardown to determine the cubic inch displacement of said engine.

1.12.7 Disqualified Boat. No E.T. or M.P.H. shall be considered for any record if the boat was disqualified on that run and would not be eligible to return to competition for a backup run as explained under "Eliminations/Grounds for Disqualification."

1.12.8 Approval of Records. No divisional or chapter record will be considered official until it is approved by the Division or Chapter Record Review Committee. No national record **will** be considered official until approved by the KENTUCKY DRAG BOAT ASSOCIATION, National Record Review Committee.

1.13 Sanction Revocation

If the event sponsor, promoter, or any of their designated officials or workers, fail to comply with any of the rules or regulations contained herein and/or the terms of the Sanction

Agreement, the Sanction Supervisor may, at his discretion, revoke the Sanction Agreement at any time prior to or during a sanctioned event. Should such a revocation occur, all participants shall be informed immediately.



RULE 2.0

MEMBERSHIP

2.1 Annual Membership

Annual membership in the KENTUCKY DRAG BOAT ASSOCIATION, or any of its divisions or chapters runs on a calendar year basis, commencing January 1st and ending December 31st of each year. The two types of annual memberships are:

2.1.1 Racing. Boat Owners and Drivers are required to fill out membership forms. All drivers of each boat must be fully paid annual racing members. An owner of the boat that is not the racer, **will** not be required to pay a membership fee. **NOTE: Owner Must fill out membership form at time of registration.**

2.1.2 Associate. Any individual, boat owner, sponsor, or promoter desiring to be an associate member for the purpose of receiving newsletters, race fliers, or other related correspondence.

Racing memberships of each member division or chapter will be recognized by all other member divisions or chapters. However, drivers who wish to accumulate points in the High Points Championship Series or set records within a particular division or chapter must be fully paid annual racing members of that division or chapter.

Membership is open to anyone without regard to race, color, creed, national origin, religion, or sex. All members will receive a membership card, newsletter, and rule book upon payment of their dues.

2.2 New Membership

New membership in the KENTUCKY DRAG BOAT ASSOCIATION, or any of its member divisions or chapters requires the submission of a properly completed application along with the required dues. All drivers of each boat must be racing members.

2.3 Membership Renewal

Memberships may be renewed by paying the required dues along with any pertinent information such as an address change. Failure by a boat driver to renew his membership prior to the dates listed for each division or chapter in Appendix B may result in the loss of his assigned boat racing number for the upcoming year. If in a previous year or years, a renewal applicant has acted in a manner (either verbally or physically) which is deemed detrimental to the KENTUCKY DRAG BOAT ASSOCIATION, a sanctioning division, member division, chapter, any Director, official, or fellow member of any member division or chapter, as well as the sport of drag boat racing in general, his application

for renewal may be denied by a vote of the Board of Directors/Competition Committee, of his member division or chapter. If denied renewal membership in his original member division or chapter based upon the foregoing, no other member division or chapter may accept said applicant as a member.

2.4 Single Event Membership

Rule Resended.

2.5 Membership Status

The membership status of a driver shall be that membership status which was recognized during the normal course of registration and shall apply to said driver throughout the entire event.

2.6 Payments and Returned Checks

All payments to the KENTUCKY DRAG BOAT ASSOCIATION, or any division or chapter thereof, must be made in U.S. funds, whether said payment is by cash or check. Any check issued and made payable to the KENTUCKY DRAG BOAT ASSOCIATION or any division or chapter thereof as payment of dues, entry fees, etc. which is returned by the bank upon which it is drawn as a direct result of any willful or intentional actions of the maker(s) of said check will result in the participant for whom the check was tendered forfeiting any and all rights and privileges to which he would have otherwise been entitled by virtue of said payment (beginning as of the date that the check was tendered). This shall include, but not be limited to, the loss of membership, the loss of voting privileges, the loss of any points awarded in the High Points Championship Series, as well as require restitution of any cash prizes which were paid to the participant. The restoration of privileges and accumulation of points will begin only after each individual check (along with the required handling fee as noted in Appendix C) has been satisfied by cash only in U.S. funds. The loss of any points and/or cash prizes is permanent; neither will be reinstated or returned. The division or chapter which receives any such returned check will notify KENTUCKY DRAG BOAT ASSOCIATION divisions or chapters in writing of said occurrence as well as notification of when reimbursement is received. If necessary, prosecution to the maximum extent allowed by law may be pursued to effect collection of the returned check(s).

2.7 Correspondence

All correspondence sent to the KENTUCKY DRAG BOAT ASSOCIATION, or any division or chapter thereof, as well as their Directors or officers, via public mail service, courier, wire service, electronic mail, or any other means now known or hereafter developed, shall become the sole property of the KENTUCKY DRAG BOAT ASSOCIATION, or said division or chapter. As such, said correspondence may be reproduced,

published, or publicly displayed in any forum or manner as the KENTUCKY DRAG BOAT ASSOCIATION, or its division or chapter so chooses.

2.8 Mailing Address

Membership applications, renewals, any other inquiries concerning membership in the KENTUCKY DRAG BOAT ASSOCIATION, or any division or chapter thereof, or requests for information concerning drag boat racing, should be sent to the appropriate address as listed in Appendix B. Any legal or general notice or document which needs to be sent to an individual participant will be sent via certified mail to the latest address furnished to the KENTUCKY DRAG BOAT ASSOCIATION, or the member division or chapter on either a membership application or race registration. Such mailing shall constitute legal service even if the participant refuses to accept or fails to claim said certified mail.

n

n

n

RULE 3.0
RACING CLASSES & STRUCTURES

All classes will race on a 1,000 ft course, with the exception of Top Fuel Hydro (TFH), which will race on an 875 ft. course.

3.1 Professional Classes

All Professional Class boats must use a driver's capsule, manufactured by a SFI Certified Manufacturer.

TFH	TOP FUEL HYDRO	
TAH	TOP ALCOHOL HYDRO	
TAF	TOP ALCOHOL FLAT	
PO	PRO OUTLAW	5.30 - 6.29
PM	PRO MODIFIED	5.60 - 6.59

Boats not conforming to the above classes will be assigned a class, once proving class capability according to Rule 7.4.4.

3.1.1 **Professional Class Structure**

3.1.1a Engines. All blown or supercharged engines, as well as un-blown fuel engines may not exceed 565 cubic inches, except in Pro Modified. No multiple engines are allowed in any class. TFH limited to 500 cu. in.

3.1.1b Blowers/Superchargers. Hi-Helix or Helix blowers are allowed in all professional classes. In addition, turbochargers, centrifugal and screw type blowers are allowed in the TAH, PO, and PM classes. Variable and multi speed blowers are not allowed.

3.1.1c Fuel. TFH may utilize only nitro-methane (sixty-five [65%] minimum) and alcohol (pure methanol). All alcohol classes must use only pure methanol. Blown Jets may utilize gasoline, alcohol (pure methanol), or a maximum of fifty percent (50%) nitro-methane. Eighty percent (80%) may be used with an un-blown top alcohol hydro (TAH) with a single propeller driven boat and ninety percent (90%) with a dual propeller driven boat. Blown jets with roots-type, Hi-Helix or Helix blowers may utilize gasoline, alcohol (pure methanol), or a maximum of fifty percent (50%) nitro-methane.

3.1.1d Hulls. TFH must use "outrigger" type hull (existing registered TFH, in 2016 are allowed). All other classes may use any hull design as designated by class, with the exception that no blown engines will be permitted in any Professional class jet boat with a V-bottom.

3.1.1e Nitrous Oxide. Nitrous oxide is not allowed in these Professional classes: TFH, TAH, TAF.

3.1.1f Propylene Oxide. Propylene oxide is not allowed in any Professional class.

3.1.lg **Water Injection.** Water injection may be used in any class; however, enough water must remain in the system after each run to allow a sample to be taken.

3.2 **Sportsman Classes (Brackets)**

QE	QUICK ELIMINATOR	6.00 - 6.99
PE	PRO ELIMNIATOR	6.50 - 7.49
TE	TOP ELIMINATOR	7.00 - 7.99
PCF	PRO COMP FLAT	6.00 --7.20
ME	MODIFIED ELIMINATOR	8.00 - 8.99

3.3 **Bracket Classes (Dial-In)**

SE/RR	STOCK ELIMINATER/RIVER RACER 9.00 seconds and over
PWC	PERSONAL WATER CRAFT 16yrs and older 9.00 and over 15yrs and younger 10.00 and over
PWC	WILL NOT be paired with a race boat

In dial-in classes e/t will be given on ramp to official before enter water. That will include pro comp flat, s/e , and personal water craft. Under no circumstance will it be gave to starter on holding rope.

3.3.1 **Sportsman & Bracket Class Structure**

3.3.1a Engines. Engines may be any

cubic inch displacement; they may be either naturally aspirated, supercharged or fuel injected, including Electronic Fuel Injection systems.

3.3.lb Blowers. Blown engines may utilize superchargers (Centrifugal, Roots, Screw, or PSI) or turbochargers; however, proper blower restraints must be used as required based upon the fuel utilized.

3.3.lc Fuel. Gasoline, alcohol (pure methanol or ethanol), nitre-methane, E-85, or nitrous oxide may be used in any engine. PWC's must use gasoline (4 stroke) or gas/oil mix (2 stroke)

3.3.ld Hulls. Any Hull design is acceptable. V-bottom jet boats using a blower, turbo charger or nitro must utilize a rudder extending a minimum of ten (10) inches below the lowest point of the transom, mounted separate from the nozzle. The nozzle must be locked in the center position.

3.3.le The above classes comprise the makeup of the KDBA racing program. A sanctioned event need not include all of the classes listed. Each of these classes, if offered, will have the same safety requirements among all member divisions or chapters. At the discretion of the sanctioning division or chapter, a minimum number of entrants may be required to constitute a class.

3.4 Optional Classes

Gambler and Second Chance will be restricted to open boats and PWC only. Boats must stay within .30 sec of the class for which the driver is licensed and/or registered. (100 mph+ requires torso type life jacket and SFI/Snell Helmet). PWC and 15

boats will run separately at the Race Directors discretion. Additional classes (i.e., Super Eliminator, etc.) may be added by the promoter. Optional classes are offered as time allows, and at the discretion of the Race Director and or promoter.

3.5 Elimination of Classes

The KENTUCKY DRAG BOAT ASSOCIATION Rules Committee reserves the right to add or delete classes at the National Level.

3.6 Pit Spaces

TAH, TAF, PRO OUTLAW, PRO MOD- 80'X30' WIDE, BOATS HAULED IN ENCLOSED TRAILERS OR ACCOMPANIED BY CAMPERS 80' OR 60' X 24' WIDE, ALL BOATS ON OPEN TRAILERS 60'X12' WIDE.

If larger space is needed, it is the boat owner's responsibility to notify race promoter and make prior arrangements. All equipment, including, but not limited to, tow vehicles, RV's, crew vehicles, golf carts, etc., must fit in assigned pit space. All others must be parked outside of pits in designated **area**.

RULE 4.0

RACING FUELS

4.1 Gasoline

Gasoline, as refined, is a mixture of hydrocarbons. Gasoline is a good electrical insulator, or dielectric, and its relative effectiveness as an insulator is represented by its Dielectric Constant (D.C.). The average D.C. for the hydrocarbons which comprise gasoline is 2.025. This is defined as a reading of zero (0) with the Fuel Check Meter. The additions of compounds containing nitrogen and/or oxygen may produce a mixture with a D.C. greater than zero. Most gasoline will meet these criteria. The addition of nitre compounds, hydrazine or its derivatives, or soluble inorganic material is forbidden. It is recommended that any unknown gasoline be checked before use at a race.

4.2 Ethanol

Ethanol (commonly referred to as grain alcohol) when used as a propellant must test pure. Testing is to be by specific gravity. Test results must measure within .002 degrees, plus or minus, or the manufacturer's purity tolerance.

4.3 Methanol

Methanol (commonly referred to as alcohol) when used as a propellant must test pure. Testing is to be by specific gravity. Test results must measure within .002 degrees, plus or minus, of the manufacturer's purity tolerance.

4.4 Nitro- Methane

Nitro Methane may be reduced by methanol only. No other chemical is allowed.

4.5 Oil Additives

The lubricating oil used within the engine is not intended to enhance the power output of the engine through the introduction of foreign chemicals or substances into the internal combustion chambers of the engine. Thus, it is strictly prohibited to add any chemical or substance to the engine lubricating oil or oil pan which is not manufactured solely for the purpose of improving the lubricating qualities of the oil itself.

4.6 Fuel Samples

4.6.1 Random gasoline, alcohol, nitro-methane mixture, water, or oil samples may be taken from any boat at any time during a sanctioned event.

4.6.2 All samples are subject to chemical analysis without prior notification to the competitor from whom the sample was obtained.

4.6.3 In order for a class record to be considered for approval, a sample of either the gasoline, alcohol, or nitro-methane mixture used by the boat must be taken by the responsible official at the out ramp immediately following both the record leg run as well as the backup run. Additionally, a water sample shall be obtained after each run if the boat utilizes water injection. If there is any suspicion of any foreign or prohibited chemical or substance having been mixed with the engines lubricating oil, then an oil sample shall also be required. No samples are required for a record backup run if the run preceded the actual record leg but did not exceed the existing record.

4.6.4 If the appropriate official is not at the out ramp when the boat comes out of the water, it will be the driver's responsibility to leave the boat at the outramp or the immediate vicinity thereof and locate the official to take the required sample.

4.6.5 The foregoing two rules also apply to each final round class winner during eliminations.

4.6.6 Refusal to allow any fuel or fluid sample to be taken has the same force and effect as though the sample had been taken and found to be illegal. The same fines and/or penalties may be imposed as indicated in Appendix C.

4.6.7 If an irregularity is detected in a participant's fuel during qualifying, that participant's qualifying round will not count; if during eliminations, the boat will be eliminated from that event and the competition for that round will be reinstated as the winner. Two irregularities at the same event, regardless of when in the program that they occur, will result in an automatic and immediate disqualification of the participant from that event. If there is a third offense at any event during the racing year involving the same participant, a suspension of three (3) races or the balance of the racing year, which is the shorter, shall be the minimum penalty. A fine as indicated in Appendix C may also be imposed.

4.6.8 If a fuel sample cannot be positively identified as to its legality after a final round win, the runner-up in the class shall also have his fuel checked. If necessary, the class monetary winnings may be withheld until such time as the fuel sample can be chemically analyzed.

RULE 5.0

WATER SAFETY

5.1 Accidents

Any boat which is involved in an accident at a sanctioned event must be re-inspected by the Safety Inspector prior to the boat being allowed to make any further qualifying, elimination, or exhibition runs. Furthermore, the boat and any part thereof are also subject to retention by the KENTUCKY DRAG BOAT ASSOCIATION, or the sanctioning division or chapter as outlined in "Retention of Boats and Parts" elsewhere in this rule book. Any driver who is involved in an accident at a sanctioned event must be examined by the medical personnel on duty at the event. Said medical personnel will make the determination as to whether the driver needs to be further examined by a physician or transported to a hospital. Refusal to allow the examination, or failure to follow the prescribed medical advice, could result in the suspension of one's Competition driver's license or notification of said refusal to the home division or chapter if the driver is competing under another division or chapter's license.

5.2 Accident Report

A report must be completed on any boat involved in an accident at a sanctioned event. The report will detail the events surrounding the accident, it's probable causes, and possible means of prevention.

5.3 Boats Under Tow

No driver, while his boat is being towed on the water, shall attempt to start his engine. While under tow, all boats must have the ignition switch as well as the fuel shut-off valve in the "off" position. In addition, the V-drive must be disengaged (out of gear). Failure to comply with any portion of this rule may result in disqualification.

5.4 Driving to the Holding Rope

When driving to the holding rope is allowed, the motor will be shut **off** as soon as the driver has reached the holding rope.

5.5 Excessive ET - Open Boats

No open boat, on any pass, will be allowed to run quicker than 5.70 sec  on a 1000' course. Any open boat running in excess of .30 seconds of its class could be subject to disciplinary action at the discretion of the Race Director.

5.6 Installation and Removal of Rudders and Drain Plugs on Ramps

Rudders that drag while towed on the trailer may be installed or removed at the ramps. Due to environmental concerns, no fuel, oil, water, or mixture thereof may be drained or pumped from a boat at either the in or out ramp. Said liquids must be disposed of properly in designated areas.

5.7 New Boats

Any driver driving a boat that is new to him/her, or new in construction, at the discretion of the Sanction supervisor, may be required to make a half (½) track safety pass, before being allowed to compete.

5.8 Safety Equipment

All safety equipment which was required to pass the safety inspection must be operational and engaged when the boat enters the water and must remain so while the boat is on the water. (Refer to Rules 8, 9, & 10)

5.9 Smoking in Boats

Smoking is not permitted in or on any race boat (on land or water).

5.10 Starting of Motors

Firing of motors on the launch ramp on trailer is strictly prohibited, unless instructed to do so by the Ramp Manager. Out boards will be allowed to warm up, while on the trailer, at a predetermined time and specific location, before racing begins. Only one crew member and the driver will be allowed on the ramp, no one will be allowed in the water at that time.

5.11 Stopping on Course

Drivers are to make a concerted effort to drive off and clear the course, allowing the Starter and Rescuer to keep the course green and the program flowing. Boats deploying parachutes shall expedite chute recovery and drive off the course if possible. Repeated offenses COULD result in loss of points (not to exceed 100) or fines (not to exceed \$250) per offense. This rule does not apply to Top Fuel Hydro. "Driving off the course" means the starter can run the next pair without waiting for your boat to be towed.

5.12 Unsafe Equipment

Any participant at a sanctioned event is subject to elimination at the event if, after passing the safety inspection, an official should determine that any of the required safety equipment is, in fact, unsafe. Should it be determined that said equipment was rendered unsafe, inoperable, or simply not activated by the

direct and intentional actions of the participant, said participant may be immediately disqualified from the event. In addition to the disqualification, the participant as well as the boat may be suspended from competition at any future sanctioned events for up to six (6) months. A notification of such suspension shall be made. A request for an appeals hearing may be made; such request should be made in writing and submitted within twenty (20) days following the date of the suspension notification. The request is to be submitted to the sanctioning division or chapter's Board of Directors.

5.13 **PWC Safety**

Drivers must keep toes and the balls of their feet in contact with the foot well. The use of permanently attached foot blocks acceptable.

5.14 **Capsule Boats Starting Gear**

In the case of any capsule boat starting in gear, the course **will** be red lit immediately and the opposing boat will be awarded the win and will advance to the next round.

If during qualifying, the boat starting in gear forfeits that qualifying attempt. The other boat will be allowed a rerun if desired. The rerun must be accomplished before the end of the days qualifying.

If during eliminations, the round win points will be automatically awarded to the other boat. The other boat is allowed a rerun if desired. The rerun must be accomplished before the next elimination round for that class. No rescheduling of the days program will be made to accommodate the rerun.

RULE 6.0

POINTS CHAMPIONSHIP SERIES

6.1 Professional Series

6.1.1 Purpose. The purpose of the Pro Championship Series is to promote the KENTUCKY DRAG BOAT ASSOCIATION, Professional Class racing series to guarantee participation of the racers, and to increase awards to the racers. Each sanctioning body will maintain its own Championship Series points/awards structure.

6.2 Sportsman and Bracket Series

6.2.1 Purpose. The purpose of the Sportsman and Bracket class championship is to provide a venue to determine a SDBA Division Champion in each class in each Division.

6.3 Procedures

6.3.1 Duration. Championship/Division Series run on a calendar year basis, commencing January 1st and ending December 31st of each year.

6.3.2 Annual Meeting. In order to receive points and/or awards in any KDBA Championship/Division Series, all owners and/or drivers of each boat must hold current, fully paid annual racing memberships in the sanctioning division or chapter and KDBA and comply with all rules and regulations as set forth in this rule book. Points towards the current years KDBA Championship shall start to accumulate on such date when the member joins KDBA.

6.3.3 Boat Number. All points in any Championship/Division Series are awarded to the boat number. Each boat participating in the series must have a separate racing number, unless an owner/driver wishes to race two or more boats that are registered and pass safety inspection, in the same class in an effort to determine which hull is the best. In this instance, the same number may be used on each boat and either boat or may be run during a specific round of qualifying. See 8.9 for further clarification. However, only one boat will be permitted to run in eliminations. If an owner has more than one boat, and separate numbers are required for each, points cannot be transferred from one boat number to another. Likewise, points cannot be transferred from one class to another should an owner decide to change classes at any time during the calendar year. If a boat is sold at any time during the racing season, points will not be transferred from the original owner to the new owner. The new owner may, however, continue to use the same boat number, subject to written authorization by the previous owner. Identical boat numbers cannot participate in simultaneous events.

Boat numbers can be transferred from one boat to another as

long as the new boat is not registered in competition at that event.

6.3.4 Participation. In order to receive any monetary awards from a Championship/Division Series, all winners and runners-up in each Championship/Division Series class must have participated in that class at a minimum of **fifty one percent (51%)** of the current years races at which the class was offered.

6.3.5 Registration/Inspection Points. At each Championship/Division Series event, each eligible boat, upon passing the required pre-race safety inspection, and properly completing the registration process, **will** be awarded one hundred (100) points.

6.3.6 Qualifying Points. At each Championship/Division Series event, each eligible boat that qualifies for the elimination program will be awarded one hundred (100) points. The boat must make a qualifying attempt as defined under "Qualifying/Qualifying Attempt" (7.6.3) in order to be awarded the one hundred (100) qualifying points.

6.3.7 Qualifying Position Points. At each Championship/Division Series events, qualifying positions are determined based upon E.T.'s (elapsed time). Within each class, the slowest boat will be awarded two (2) points, the second slowest boat **will** be awarded four (4) points, and each successive qualifying position will be awarded points in increasing increments of two (2) except the number one (1) qualifier will increase an increment of four (4) points. Qualifying position points will not be awarded if the boat made no qualifying attempt as defined under "Qualifying/Qualifying Attempt." For example, if the seventh boat in a seven-boat field did not make a qualifying attempt, said boat would still be placed on the ladder in the seventh position, but would not receive the two qualifying position points for that position. The sixth boat however, would still receive his normal qualifying position points (in this case, four), regardless of the fact that the boat below him received no points. No qualifying position points will be awarded to any Top Fuel Hydro beyond the eighth (8th) qualifying position, and no qualifying position points will be awarded to any TAH beyond the sixteenth (16th) qualifying position. All other classes will be awarded qualifying position points up to and including the thirty-second (32nd) position. Any boat which makes a valid qualifying attempt and is subsequently declared broken or voluntarily withdrawn from the racing program will be awarded the appropriate qualifying position points, although the boat will not be included in the class pairings for eliminations. Any boat which is inserted into the first round of eliminations as an alternate boat will not be awarded any qualifying position points. Furthermore, no qualifying position points will be awarded to any boat if qualifying is canceled and the boats are paired either by Championship Series Points or by drawing lots.

6.3.8 Official Record Points. At each KENTUCKY DRAG BOAT ASSOCIATION event, 25 points will be awarded for setting, an official record (MPH or ET) per race event.

6.3.9 Round Winner Points. At each Championship/Division Series event, one hundred (100) points will be awarded to each round winner during eliminations.

6.3.10 Official Error. At any Championship/Division Series event, no points whatsoever will be awarded for an official error, unless an official inadvertently awarded points to the wrong competitor. In that instance, the points would be deducted from the incorrect competitor's total and awarded to the proper participant.

6.3.11 Retention of Points. Any boat which is eliminated, disqualified, declared broken, or voluntarily withdrawn from the racing program at any point during an event will retain all points earned up to the point of elimination, disqualification, etc.

6.3.12 Incomplete Race. At all Championship/Division Series events which are not completed for any reason whatsoever, round winner points will be awarded only for fully completed class rounds. If a race is stopped and subsequently canceled in the middle of any class round, no round winner points for the eliminations round which was interrupted will be awarded to any boats in the incomplete class.

6.3.13 Series/Division Winners. Each class winner and runner-up in the Championship/ Division Series will be determined by total points accumulated in their class throughout the year. The boat that has earned the highest total points in each class is the winner in that class; the boat with the second highest total points is the runner-up in that class.

6.3.14 Tie Breaking. If there is a tie in total points within a class at the end of the year, the Championship Series winner and runner-up shall be determined by using the following criteria, in the order listed, to break the tie:

6.3.16a The total number of Championship Series events won by each boat.

6.3.16b The total number of second place (runner-up) finishes by each boat at Championship Series events.

6.3.16c The total number of eliminations rounds won by each boat at Championship Series events.

6.3.16d The greater number of wins by each boat in heads-up competition between the tying boats at Championship Series events.

6.13e The total number of Championship Series events at which each boat qualified.

If the above fails to break the tie, the two (or more) boats shall be declared co-winners.

RULE 7.0

COMPETITION RULES

7.1 Safety/Tech Inspection

Driver's personal safety equipment as well as the boat and its related safety equipment must pass Safety/Tech inspection, before being allowed to test and tune, qualify, or run in eliminations.

PO boats of hydroplane design must pass PM tech. PO non-hydroplane hull design must pass TAF/TFH tech. Screw blowers allowed.

7.2 Drivers Meeting

If roll call is taken, any driver who is absent **will** be required to meet with the Sanction Supervisor and/or Race Director, to explain the reason(s) for their absence, prior to participating. Failure to attend mandatory Drivers Meetings may result in the driver's disqualification for the event.

7.3 Competition Driver's License

7.3.1 Class Requirement. All drivers in TFH, TAH, TAF, Pro Mod, PE, QE, and TE classes, participating in a sanctioned event are required to have a valid Competition Driver's License for the class in which they intend to compete. No driver will be allowed to enter competition without a Competition Driver's License. Competition Drivers Licenses from each division or chapter will be recognized by all other divisions or chapters. If racing using another association's license, and said driver wishes to obtain a Competition Driver's License from a different sanctioning division or chapter, the sanctioning division or chapter will issue its license only after observing said driver throughout the entire event (assuming that said driver passes all the sanctioning division or chapters requirements for the license). An issued license can be used only by the driver to whom it was assigned.

Under no circumstances **will** a boat that is in competition be allowed to be used for a license pass for another driver once qualifying has been completed. **No** license passes will be allowed on Elimination Race Day.

7.3.2 Med I Tag. All drivers, in all classes are required to wear their Med I Tag around their neck at all times when operating a boat.

7.3.3 Age Requirements. All drivers in the Professional and Sportsman classes must have attained a minimum age of eighteen (18) years in order to apply for and be granted a Competition Driver's License. Drivers in the RR, SE and ME classes are not required to have a Competition Driver's License, but they must have attained a minimum age of sixteen

0

(16) years. PWC must be a minimum age of 12. Any competitor under the age of 16 must have completed a state approved boater's safety course. Any PWC competitor dialing in an E.T. under 9.99 must be 16 years of age and have a valid, state issued driver's license.

n

7.3.4 Physical. No physical is required for any Bracket class or any other class running 10:00 seconds or slower. Each driver in the Professional and Sportsman classes is required to take a physical prior to applying for a Competition Driver's License. The standard physical form provided by your sanctioning division or chapter is to be used; however, a DOT/FAA physical form will also be accepted. This physical is required to be performed every two years. It is the responsibility of the driver to have his physical form available at the first race of the season at which he applies for a new or renewal Competition Driver's License. Any driver who is found to have submitted a fraudulent physical form shall be subject to having his home division or chapters license suspended or revoked (to be determined by the Board of Directors) in addition to, or in lieu of a fine as noted in Appendix C. There is no grace period if a driver doesnot have a physical.

7.3.5 Duration of License. All Competition Drivers Licenses are issued for a two (2) year period or until physical expiration date and will coincide with the driver's physical date. A fee set by the individual sanctioning body will be charged for the license. It is the driver's responsibility to keep the license and physical current.

7.3.6 Class Restriction. No driver will be allowed to drive a boat in any class higher or quicker than the one specified on his license. In any class where different engine and hull combinations are permitted, the driver's license will indicate the actual engine and/or hull combination which is authorized (i.e., TFH, TAF, 8:00Jet, 8:00Flat, etc.).

7.3.7 Visual Aid. The Competition Driver's License **will** indicate if visual aid is required in order to drive (as indicated on the driver's state driving license or on his physical form).

7.3.8 Class Upgrade. Any driver holding a valid Competition Driver's License who wishes to upgrade to another class must pass the same driving test as required of a new driver. If, however, the driver will be driving the same boat in which he has previously been competing, his qualifying passes may be considered as his driving test. If this option is exercised, the qualifying passes will be run as single lane passes. The qualifying passes must be representative of the class for which the driver is attempting to license and will be observed by the appropriate personnel to determine if the driver qualifies for the upgrade. No new physical examination will be required providing that his current Competition Driver's License has not expired.

7.3.9 License Renewal. In order to renew a Competition Driver's license, a driver must submit a renewal application along with a new physical examination (see "Physical" above). If a license has expired and remained inactive for six (6) months or longer, the driver, at the Sanction Supervisor or Race Directors discretion may be required to take a new Competition Driver's License test.

7.3.10 License Suspension/Revocation. Any driver found violating the rules or regulations contained herein or failing to follow proper directions of any sanctioning division or chapter official shall be subject to having his Competition Driver's License suspended or revoked. A Competition Driver's License may also be suspended or revoked for serious infractions of the rules of another drag boat racing association if the driver was competing at another association's race using his home division or chapters Competition Driver's License. The division issuing the license would act in such an instance only after receiving a formal written notification from the other association detailing the problem(s). At that point, the Board of Directors/Competition Committee of the division or chapter which issued the license would thoroughly review the situation and make a decision.

7.3.11 Driver's License Test.

7.3.11a In order for a new driver to obtain a Competition Driver's License, he must have the physical examination completed prior to his arrival at the race event (see "Physical" above).

7.3.11b The Race Director or designee shall be responsible for instructing the testing driver as to what requirements will be needed to pass test. The driving test must be conducted at a sanctioned event (includes sanctioned test and tune events). Arrangements for the driving test must be made at the time of registration. All test runs will be single lane runs. No side by side runs will be permitted during Competition Driver's License testing. The following test runs must be accomplished in the order in which they are listed: A first-half course run. This is to be an acceleration run, beginning at the starting line and ending with deceleration at mid-course. A full course pass, with safe shutdown and must be representative of the class for which the driver has applied. In Pro Mod, PE, QE, and TE classes, the full course pass must be within .49 sec for the class the Driver is testing for. TAF must attain an elapsed time (E.T.) of 6.00 or quicker and TAH 5.00 or quicker in order to obtain a license in these classes. The full course run may be the first qualifying pass made by the driver, as long as it is run in

that class during a normal qualifying session, and the driver's license test is successfully completed. Both test runs shall be closely monitored and observed by the appropriate officials. New drivers and upgrades are not guaranteed that they will be issued their Competition Driver's License and subsequently allowed into competition at the same event as they apply for the license.

7.4 Registration

7.4.1 At their discretion, the KENTUCKY DRAG BOAT ASSOCIATION, as well as the sanctioning division or chapter reserve the right to refuse to allow any person or persons to register and/or participate in any sanctioned event. The following must be accomplished prior to leaving the registration area.

7.4.1a Racing membership verified for all owners and all drivers of each boat.

7.4.1b Competition Driver's License checked for class and expiration date for all drivers of each boat.

7.4.1c All forms and releases must be completed and signed by each owner, driver, and crew member.

7.4.1d Payment of all dues, fees, etc. A receipt will be issued for all monies paid.

7.4.1e No one will be granted a pit space without a boat that can pass tech. No crew passes will be issued. Spectator vehicle, RV, and people passes will be required.

No boat **will** be allowed to attempt to test and tune, qualify, or compete in eliminations without all of the above items having been completed and passing Safety/Tech inspection.

7.4.2 Membership/Forms/Releases. All owners and all drivers of each boat registering to compete in a sanctioned event must be fully paid annual racing members of one of the member divisions; otherwise the owners and each driver must join the sanctioning division or chapter. The owner's racing number must match the number on the boat. Boat numbers cannot be changed nor hull ownership transferred after the boat has once registered at any specific event. The driver of the boat must have a valid Competition Driver's License for the class in which he desires to register. Each owner, driver, and participant must also execute and sign any and all registration and release forms as required.

7.4.3 One Boat/One Class. All boats may compete in only one class **at** any one event. Participants must pick a class in which to register and attempt to qualify; however, after qualifying, they will be permitted to change to any other class for which they are qualified if they so desire. See

"Qualifying/Class Changes" elsewhere in this rule book for a more detailed explanation. At the discretion of the Sanction Supervisor, one boat may enter multiple classes at pre-specified events. Drivers/Owners within the applicable Division/Chapter will be notified in advance of the event.

7.4.4 Class Capability. A boat may enter any class as long as it meets all the criteria for that class as set forth in this rule book and has the capability of running speeds and elapsed times representative of that class. The Sanction Supervisor shall have the final decision as to the capability of any boat. The purpose of this rule is to prevent a boat from entering a class for the sole purpose of increasing the purse in that class when the purse structure is based on the number of boats entered.

7.4.5 Multiple Drivers/One Boat. If there is more than one driver for any particular boat, each driver must be a fully paid annual racing member of one of the member divisions and have a valid Competition Driver's License for the class in which the boat is being registered. Furthermore, each driver must execute and sign all required registration and release forms.

7.4.6 Safety Pass. A safety pass must be requested by the Race Director and is designed to allow officials to observe the boat and driver, to determine the safety of both to compete. All safety passes must be run as ½ track single s unless otherwise directed by the Race Director. No Start Clock, ET or MPH will be received, and will be run if time allows. Failure to complete a safety pass will keep that driver/boat in the safety pass mode, until Race Director approves return to competition.

7.4.7 Exhibition Pass. Allowed once the boat is out of competition, if time allows and will receive ET and MPH.

7.4.8 Suspension. No boat will be allowed to register or participate in any sanctioned event if KDBA or the sanctioning division or chapter has been formally notified in writing of a suspension from competition involving the owner, driver, or any crew member by any of the other major drag boat racing sanctioning bodies. Only the sanctioning body which originated the suspension may, in writing, revoke the suspension. Any owner, driver, or crew member who is suspended as described herein may appeal his suspension to SDBA Rules Committee. Their decision shall be final.

7.4.9 Entry Fees. Entry fees for a particular event are set by the sanctioning association of that event.

7.4.10 Registration Closed. No boat will be allowed to register after registration has been officially closed, unless prior approval is received from the Sanction Supervisor.

7.4.11 Boat Ownership at Event. Once a boat has been registered at the event it may not be sold and raced under another number.

7.4.12 Time Slips. Time slips shall be available to all boats making a pass, with the exception of boats making a safety pass.

7.5 Starting Procedures

7.5.1 Point of View. All references herein shall be as seen by a driver sitting in a boat at the starting line holding rope.

7.5.2 Holding Ropes. The starting line holding rope shall be located one hundred and twenty-five (125) feet behind the starting line. The holding rope shall be marked with a red streamer to mark the outside of the respective lane. This red marker shall be the holding spot for the next boat to run in that lane. An additional red streamer shall mark the closest point that a boat may line up next to the starters platform. A yellow streamer will mark the center of each lane.

7.5.3 Reaction Timers. Reaction timers will be an integral part of the official starting system. In the unlikely event of a system malfunction which causes the foul start light to work improperly, the reaction times may be used to determine foul starts. Reaction times for each competitor shall be posted at the timing tower along with the E.T. and M.P.H. for each run.

7.5.4 Starting Clock. All race courses will use the official starting clock and timing system furnished by the sanctioning division or chapter. The lights on the right side of the clock will represent the right lane, and those on the left side, the left lane. The lights for each lane shall be situated vertically, commencing with red at the top, amber in the center, and green at the bottom. The computer will be the deciding factor in a foul situation if a discrepancy occurs between the reaction time and the starting clock, unless it is an obvious malfunction of the equipment.

7.5.5 Starting Clock Definitions. Each of the following definitions of starting clock light functions applies to either lane.

7.5.5a Red Lights. Course Closed! Drivers must come to an immediate stop. Do not proceed any further until so instructed by the Starter. Failure to heed the red lights is grounds for disqualification (determination to be made at the discretion of the Starter). Starting of engines while the Red Light (if used) is on will void that run.

7.5.5 b Blinking/Solid Amber Light. This indicates to the driver that the starting clock countdown is imminent. Watch the clock closely! Engines should be running.

7.5.Sc Solid Green Light. Indicated a legal start. GO!

7.5.Sd Solid Red Light. Indicates that a foul start has occurred in that particular lane. The boat in the lane displaying the solid red light has broken the starting line light sensor beam prior to receiving a green light.

7.5.6 Starting Sequence: KDBA

- ❖ Course red lights are on.
- ❖ Starter will notify the next driver (using his boat number) to watch the lights.
- ❖ Amber lights will begin flashing for twenty-five (25) seconds, at which time each driver may commence his starting procedure.
- ❖ After the amber lights have flashed for twenty-five (25) seconds, they will go solid for five (5) seconds. This will be a warning that the countdown is about to begin.
- ❖ After the five (5) second warning, the solid amber lights will go out and the countdown will begin. The countdown will start at "20" and will count down to "0" in half second increments. When the clock says "0", the green light(s) will come on. Should a boat cross the starting line before the green light comes on, a red light will light, indicating that a foul start has occurred in that lane.

After displaying either a solid green or red light, the lights will go out a minimum of five (5) seconds after the lead boat has crossed the starting line.

7.6 Qualifying

7.6.1 Driver Limitation. Each driver who enters competition at a sanctioned event will be permitted with approval from the Sanction Supervisor to drive more than one boat during qualifying. If driving boats in different classes, the driver must be licensed for each class. Qualifying will not be held up at any point to accommodate a driver wishing to drive a second boat.

7.6.2 Number of Qualifiers. All classes except Top Alcohol Flat, Top Alcohol Hydro, and Top Fuel Hydro shall consist of thirty-two (32) boat fields at divisional races as well as National Series Events. Top Alcohol Flat and Top Alcohol Hydro will be limited to a sixteen (16) boat field and Top Fuel Hydro to an eight (8) boat field.

7.6.3 Qualifying Attempt. All boats will be given an opportunity to qualify by class in order to compete in eliminations. Any boat that does not report to the launch ramp and complete a qualifying attempt when called by class **will** receive no time as well as no makeup pass. A qualifying attempt is defined as a boat starting its engine and leaving the holding rope when so instructed, under its own power and subsequently crossing the start line. No repair work, requiring outside assistance will be allowed for any boat once it has been launched into the water.

7.6.4 Qualifying Attempt Voided. On any qualifying attempt, any driver who snags the holding rope due to his or his crew's own negligence, hits any of the timing equipment, or runs outside of his lane boundaries, will forfeit that qualifying attempt and receive no makeup. The owner of any boat which damages any association equipment may be held liable for the cost of said equipment.

7.6.5 Foul Start (Red Light). During qualifying, any competitor who commits a foul start will not be penalized. The boat will receive both the E.T. and M.P.H. for that run, and the run will still be considered a valid qualifying run.

7.6.6 Breakout/Failure to Prove Capability. During qualifying, any E.T. format class boat that breaks out or fails to prove capability for the class will not be eliminated or penalized in any manner. However, qualifying positions will be affected as described under "Pairing for Eliminations."

7.6.7 Identical E.T.'s. If two or more boats in the same class record identical E.T.s during qualifying, the boat registering the Reaction Time (R.T.), shall be considered the quicker for the purposes of pairing for eliminations. If the boats

were to have both identical E.T.s and R.T.'s then the boat which first recorded the E.T. would be considered the quicker for the purposes of pairing for eliminations. In the event that the run was a dead heat, that round would be rerun.

7.6.8 **Official Error/Malfunction.** Should any competitor fail to receive an E.T. on any qualifying run due to either an official error or a mechanical malfunction of the timing system, every effort shall be made to give that boat a makeup run.

7.6.9 **Class Changes.** If any competitor wishes to change from the class in which he registered, it is his responsibility to notify the timing tower within thirty (30) minutes of the cancellation or conclusion of qualifying as to what class in which he wishes to compete. If any owner or driver changes classes pursuant to this rule, the qualifying E.T.s will be transferred to the declared class and be used for pairing purposes accordingly. Likewise, all points including registration, qualifying, qualifying position, etc. will be awarded in the declared class. No boat will be permitted to move to a quicker class if the safety requirements for that class have not or cannot be met. Only the owner or driver may request to change classes, and he must sign the appropriate form at the timing tower in order to effect the change. Failure to notify the timing tower of a desire to change classes will result in the boat remaining in the class in which it was registered.

7.6.10 **Qualifying Incomplete.** If qualifying is not completed at any sanctioned race, no E.T.'s from any incomplete class round will be considered for qualifying purposes. A class round is considered complete when the class is called to the ramp, launched, and each boat which proceeds to the starting line holding rope has been given an opportunity to make a qualifying attempt. If a class round is interrupted in the middle of the round, the E.T.s for the boats which have run will not be considered unless the remainder of the class is subsequently able to complete that round. If the interruption requires that the boats be removed from the water, only those boats which were on the starting line holding rope and were not permitted to make a qualifying attempt will be allowed to return to the water if the class is recalled at a later time. Any class which is unable to complete its first round of qualifying will be paired as outlined under "Qualifying Canceled."

7.6.11 **Qualifying Canceled.** If qualifying is canceled at the first race of the season, boats shall draw lots for the purpose of pairing for eliminations. At any subsequent race, the boats will be paired by class for eliminations using the Championship Series point totals for each boat (highest number of points equals #1 qualifier; second highest number of points equals #2 qualifier, etc.). Boats having no points shall draw lots for the remaining qualifying positions. If qualifying is canceled, all competitors must run in the class in which they registered, unless they notify the timing tower of a desire to change classes as explained previously in this section under "Class Changes." If

in the opinion of both the Sanction Supervisor and Race Director, a single round of qualifying can be accomplished on the day of eliminations, this option may be exercised. Their decision shall be final.

7.6.12 Qualifying on Shortened Course.

7.6.12a In the event of adverse weather conditions or other uncontrollable factors which prevent qualifications to be held or completed on the full-length course, the Race Director may elect to hold qualifications on an alternate-length course, as conditions dictate. This decision will be solely the decision of the Race Director and will be made on a class-by-class basis, depending upon conditions.

7.6.12 b If and when conditions allow, at the Race Director's direction the course may revert back to the normal length. All boats in each class will run their qualification run(s) on the same length course. In the event one full qualifying round is made on the normal course, and another round is run on the alternate course, the qualifying round made on the normal course will determine the official qualifying position.

7.6.13 660' Qualifying Eliminations.

Pro Outlaw	3.80
Pro Mod	4.10
QE	4.40
PE	4.70
PCF	4.40/ 5.60
TE	4.90
ME	5.60

SE 6.50 under

PWC 6.50 16 yrs & Older

PWC 7.50 15 yrs & younger



7.7 **Eliminations**

7.7 .1 Pairings. Pairing for eliminations shall be based upon the lowest legitimate qualifying E.T. for each boat. Boats will be placed on the standard ladder system according to their respective E.T.'s and the number of boats in their class. If, in any E.T. format class, none of the qualifying E.T.s fall within the E.T. range of the class in which the boat was registered, but the owner and/or driver has elected to remain in that class, the boat will be considered the slow boat in the class and paired for eliminations accordingly. Should there be more than one boat in any class which has no qualifying E.T.s within the E.T. bracket; said boats will be assigned qualifying positions below those boats that legitimately qualified for the class. These boats will be assigned qualifying positions beginning with the boat which broke out of the E.T. bracket by the least amount, followed by all other boats which broke out in ascending order of the breakout amount. In turn, they will be followed by the boat that failed to prove capability by the least amount, followed by all other boats that failed to prove capability in ascending order of the failure to prove capability.

7.7.2 Broken/Damaged Boats. During qualifying, any boat that suffers HULL damage or major mechanical failure will not be paired for eliminations. These and boats must report to the tower 30 minutes after qualifying to Declare broke. If the crew is able to make repairs overnight and tech passes the repairs, they can report to the tower one (1) hour before the First Round of Racing Eliminations begins to Declare UNbroken and be inserted back into the ladders as the slowest boat.

No other pairing will take place unless there is an official error.

SEE FOLLOWING PAGES FOR PAIRING LADDERS

Pairing Ladders

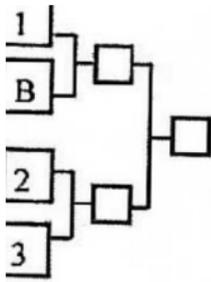

5

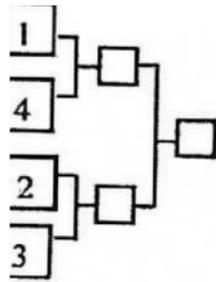

6

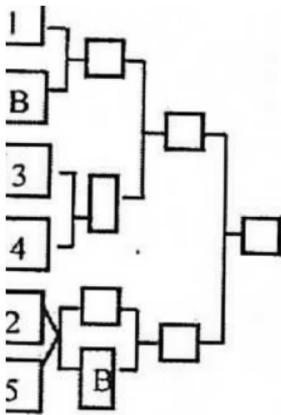

7

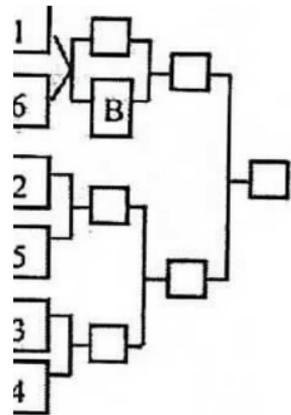

8

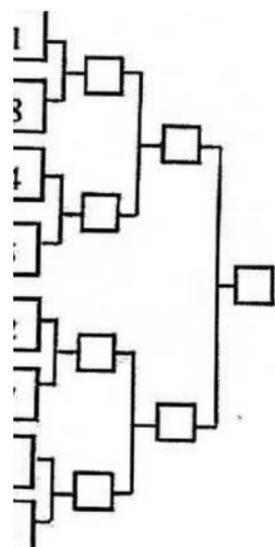
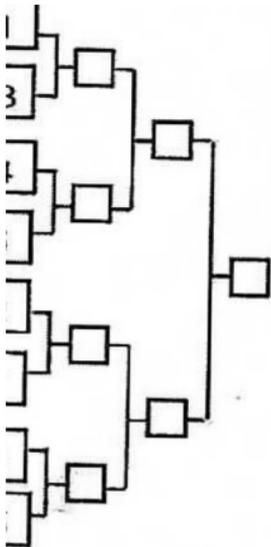

-Pairing Ladders

10

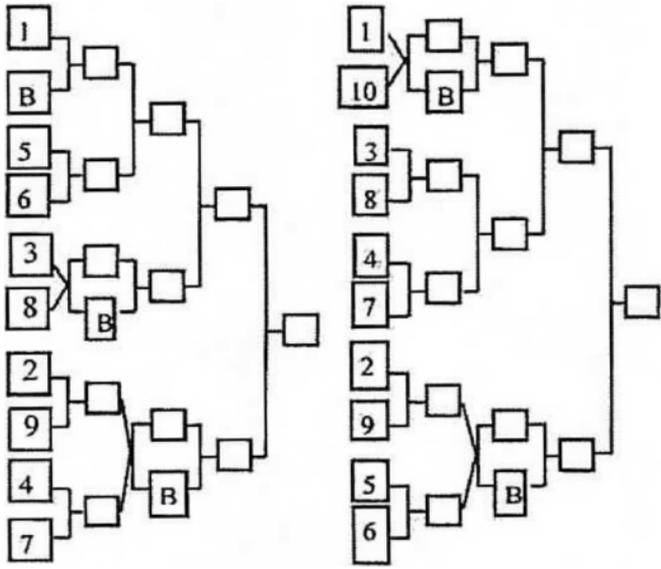

11

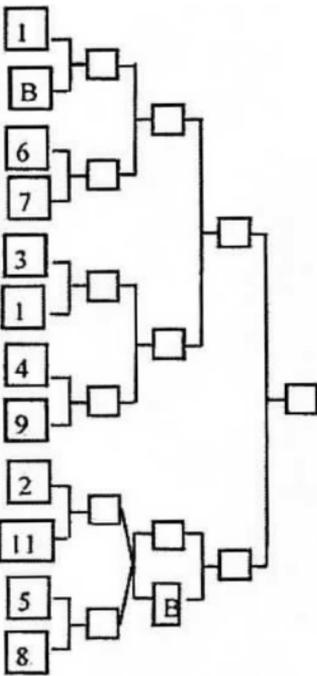

12

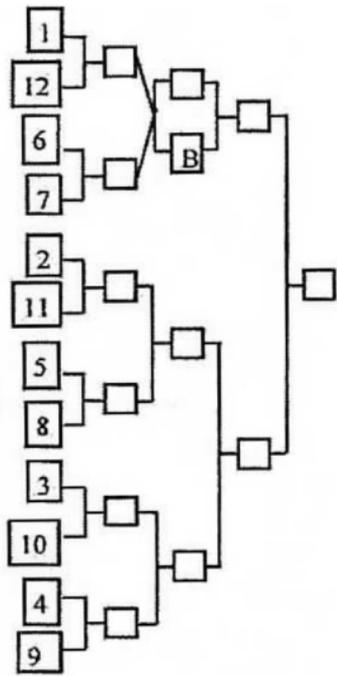

Pairing Ladders

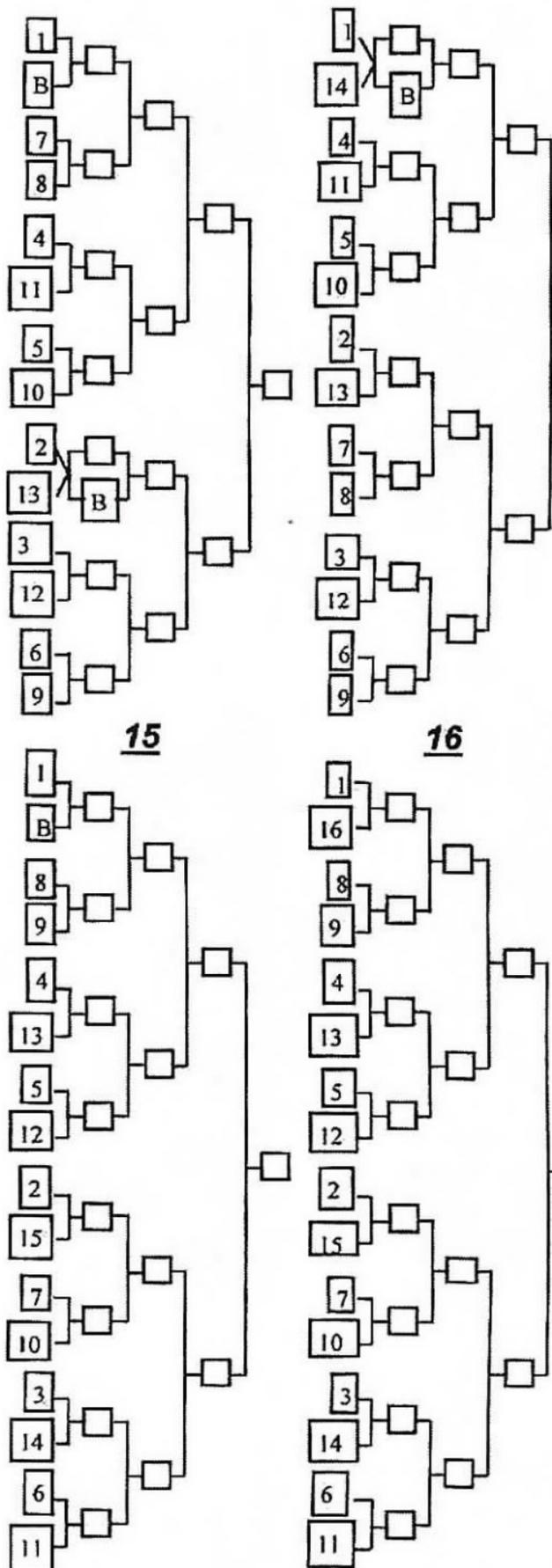

Pairing Ladders

17

18

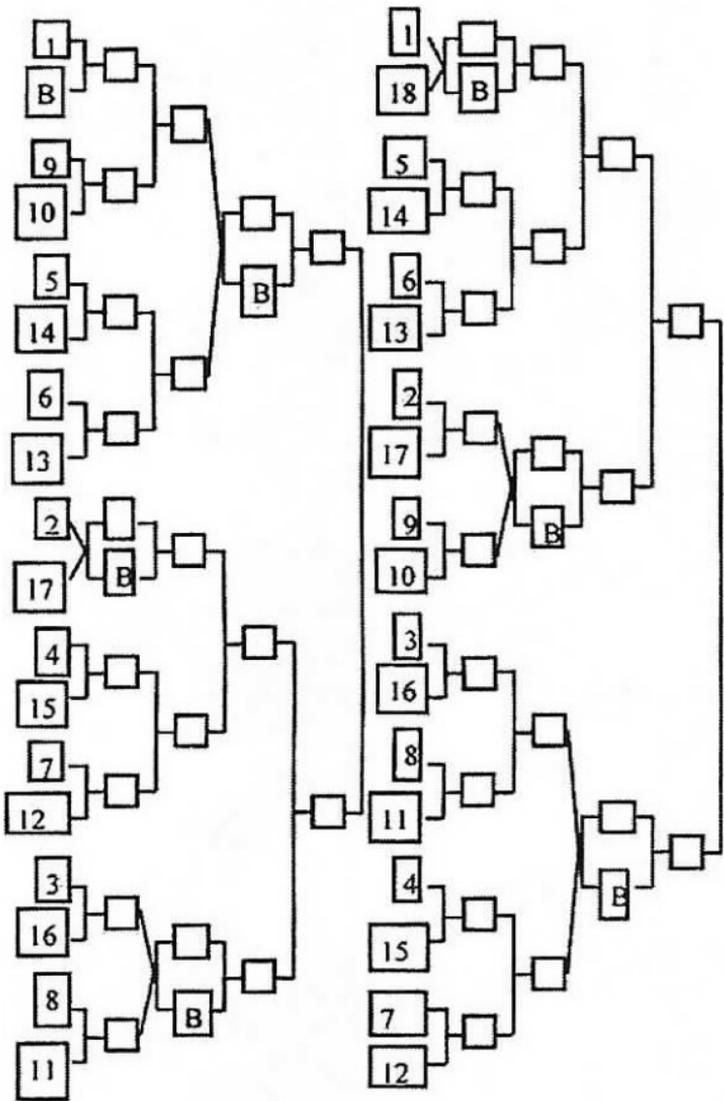

Pairing Ladders

19

20

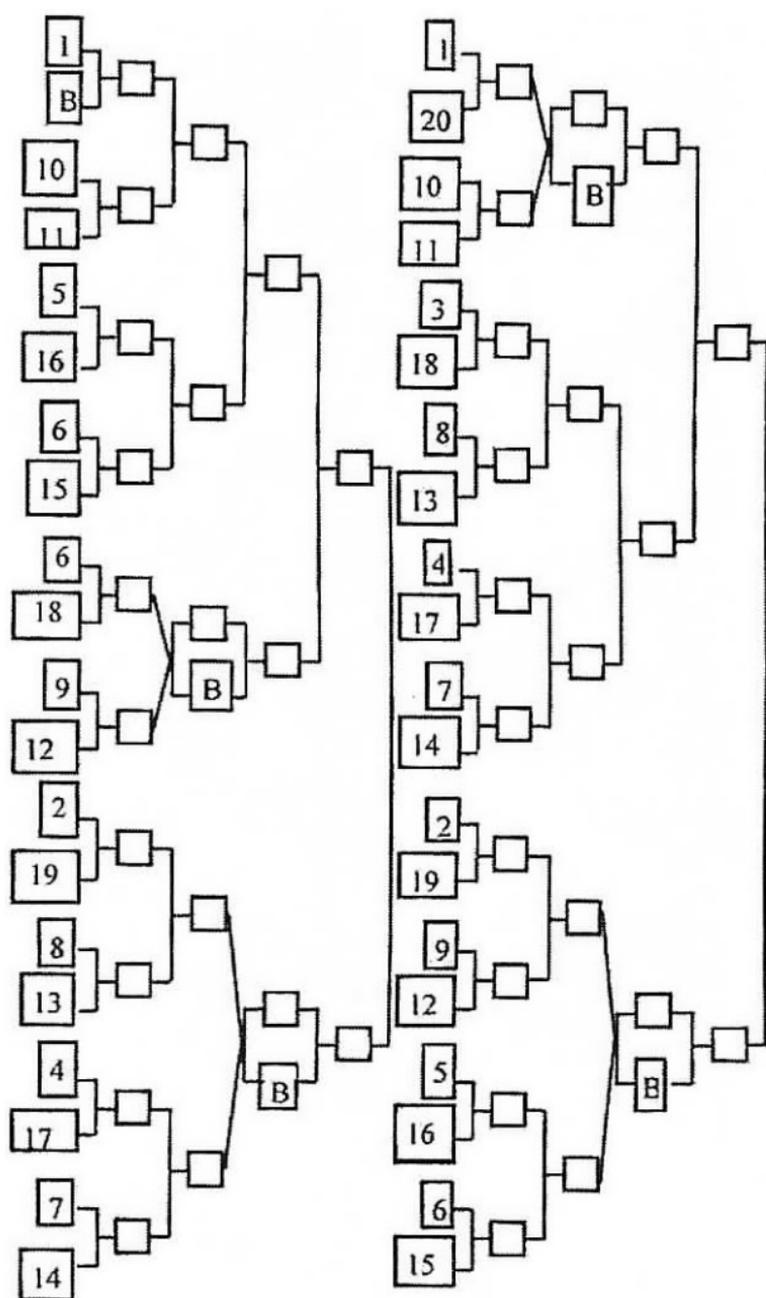

Pairing Ladders

21

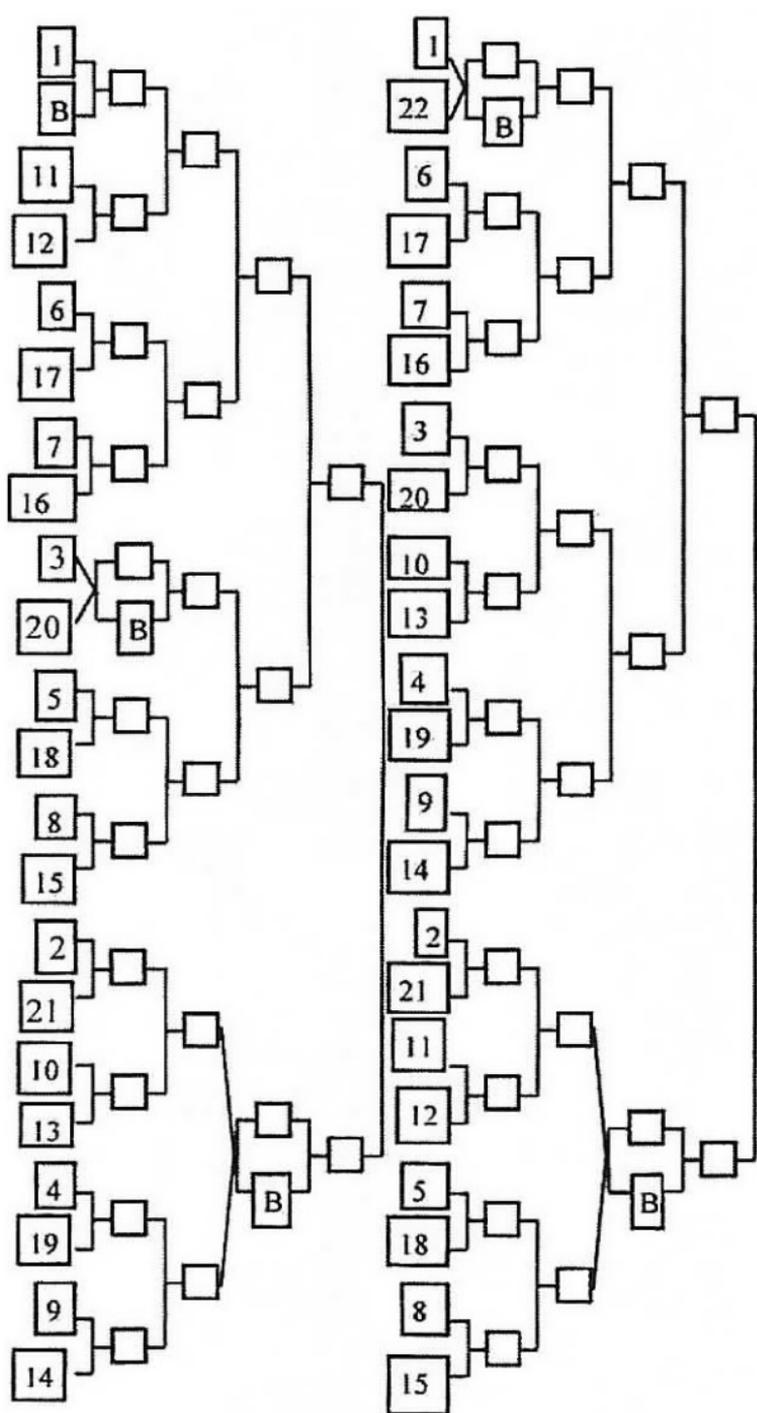

Pairing Ladders

23

24

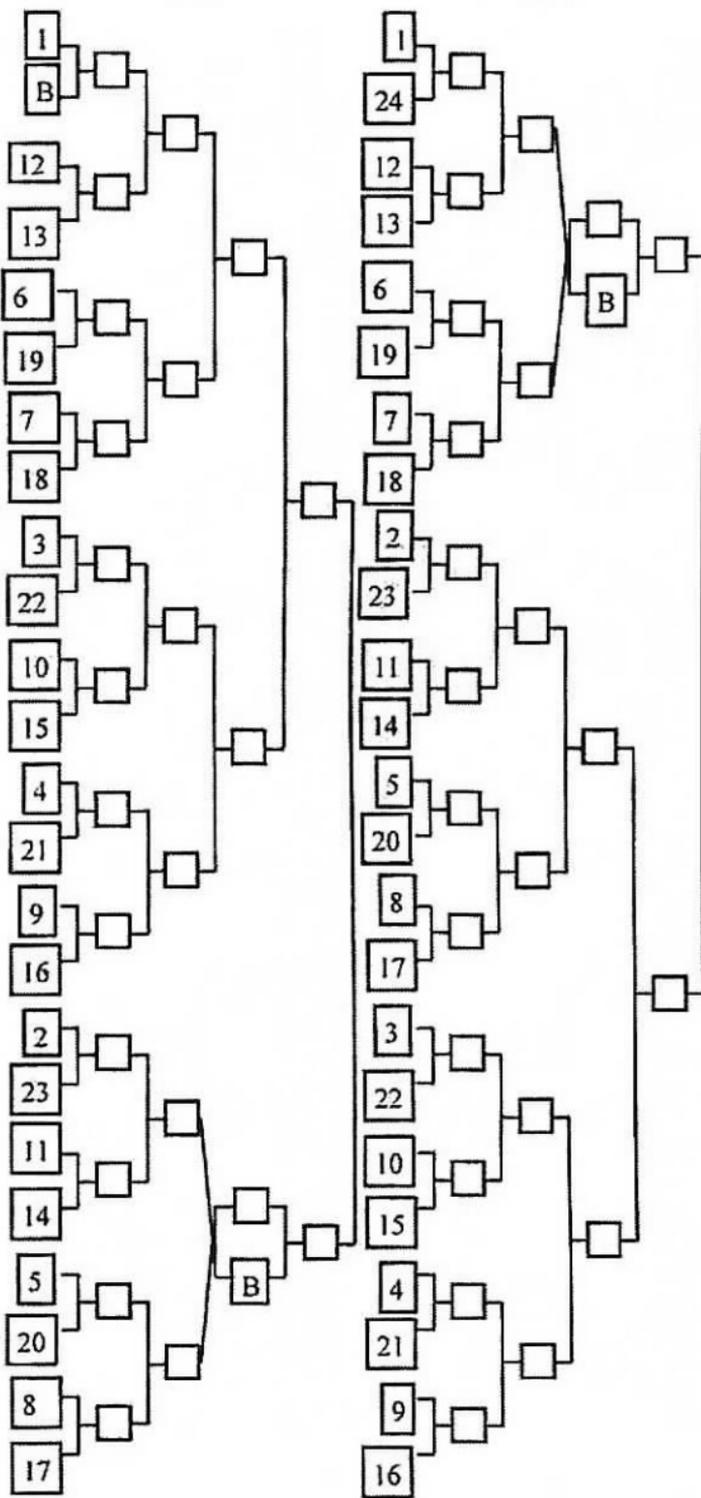

Pairing Ladders

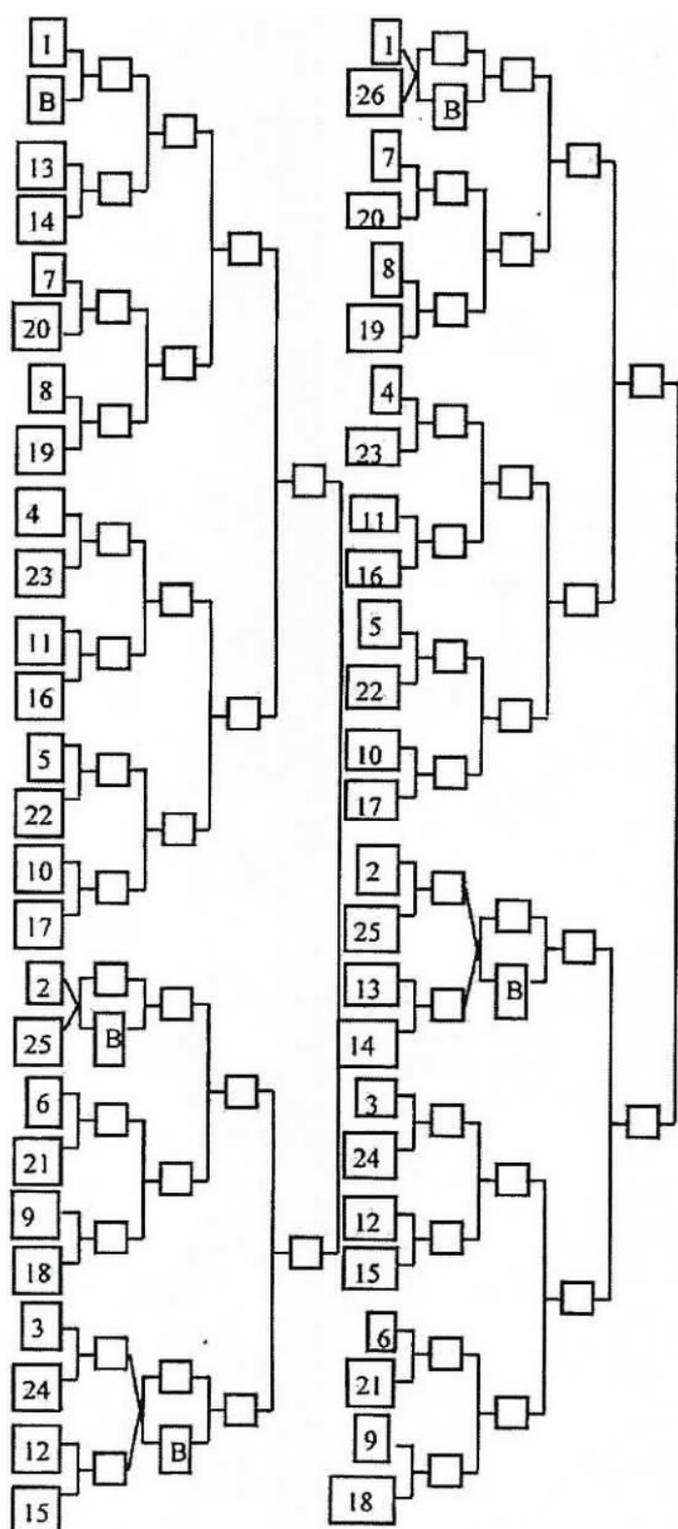

Pairing Ladders

27

28

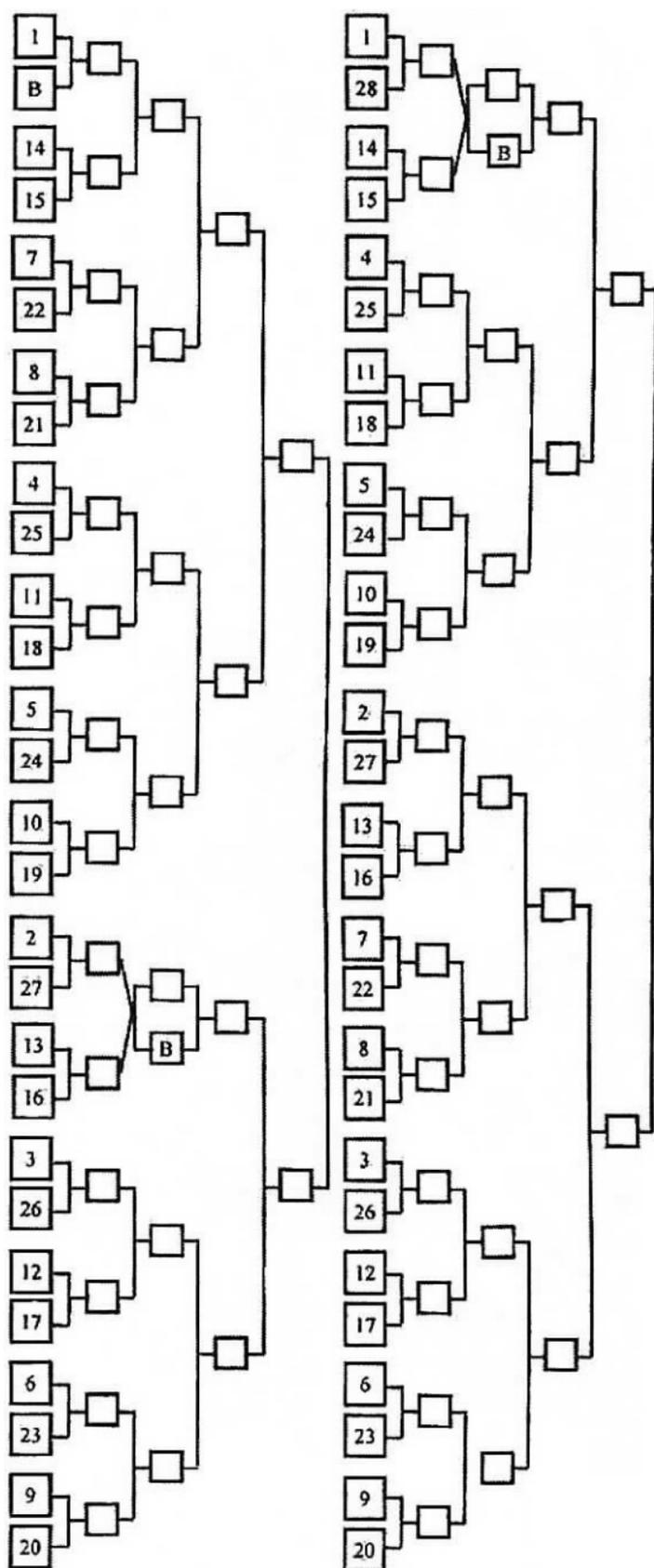

Pairing Ladders

29

30

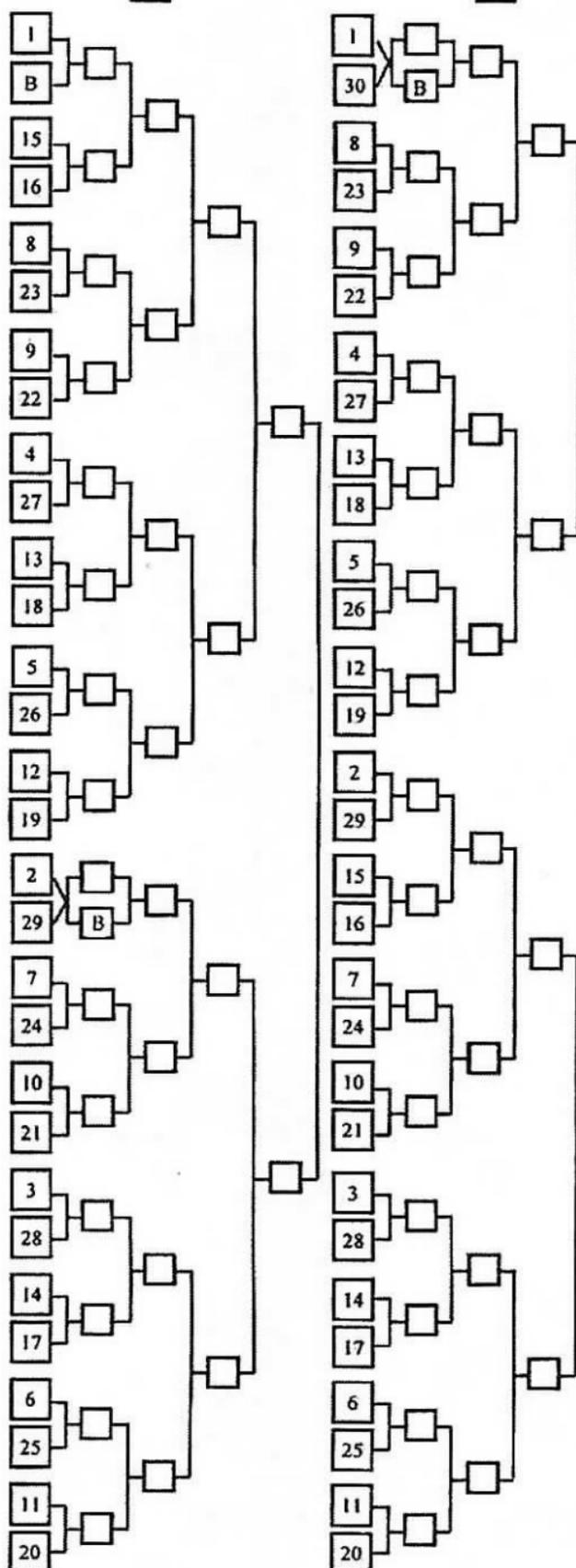

n
n

31 *Pairing Ladders* 32

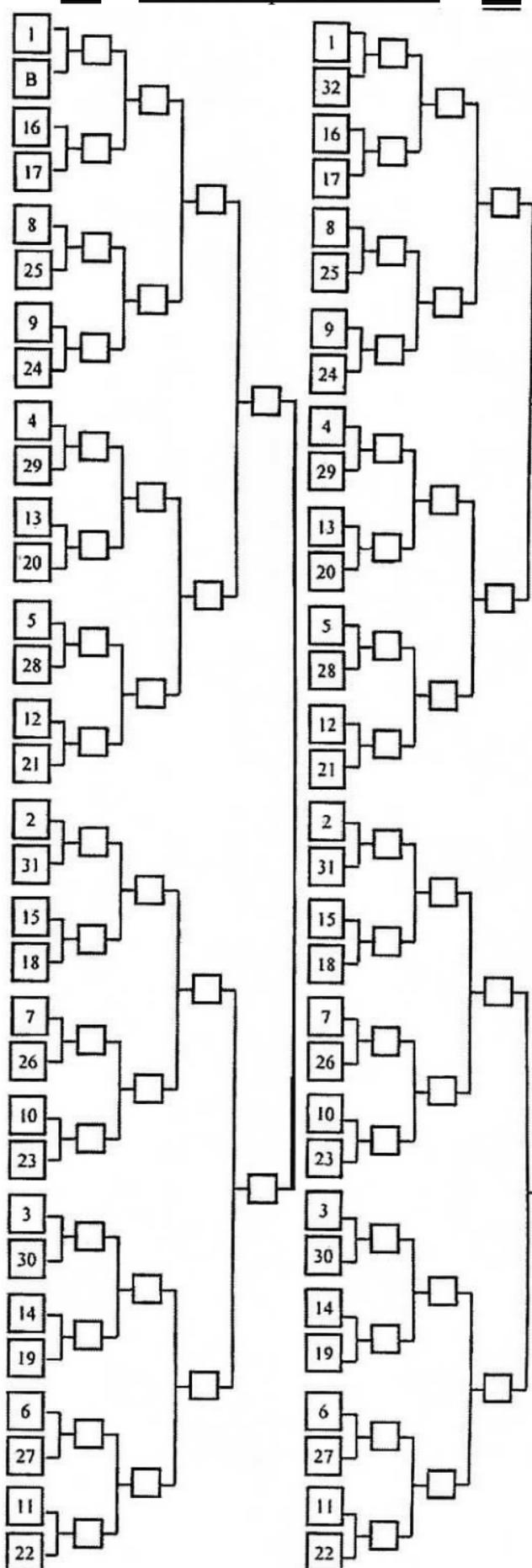

7.7.3 Driver Limitation.

7.7.3a Each driver who enters competition at a sanctioned event will be permitted to drive only one boat in the same class during eliminations, unless that boat is eliminated, declared broken, or voluntarily withdrawn from the racing program during eliminations. At that point, said driver will be eligible to drive one other boat, and one other boat only. If the driver is driving a second boat pursuant to this rule, and the second boat is either eliminated, declared broken, or voluntarily withdrawn from the racing program, that driver would not be eligible to drive any other boat at that event.

7.3.3b At the discretion of the Sanction Supervisor, a driver may be allowed to drive a second boat in another Class. Eliminations will not be held up at any point to accommodate a driver wishing to drive a second boat.

7.7.4 Order of Eliminations/ Pairings. The order in which the classes will be called for competition as well as the pairings for the first round of eliminations shall be posted at the timing tower (or other designated location) prior to the commencement of eliminations.

7.7.5 Lane Selection. The slower boat in all classes shall be run in the inside (spectator) lane when practical. TFH, TAH, TAF, PM & PO have lane choice every round, by previous round ET. Other classes: lane choice final round only.

7.7.6 Warm-Up Time. Time permitting, each class **will** be given one half-hour notice to warm engines prior to their ramp call for the first round of eliminations. Thereafter, as much notification will be given as the situation permits. All decisions regarding warm-up time will be made at the discretion of the Race Director.

7.7.7 Ramp Call/Launch. When a class is called to the launch ramp for the first round of eliminations, all boats in the class must report including the alternate boats (except the bye run boat if he chooses not to run). If any boat fails to launch when instructed, the alternate boat will be inserted into the slot by the ramp manager. No repair work requiring outside assistance will be allowed once the boat has been launched into the water.

If there are more boats than the allowed "number of qualifiers" (Rule 7.6.2) allowed in a class, then the alternate boat(s) shall be notified and report to the launch ramp when the class is called for the first round of eliminations. The alternate boat(s) will be the first next in line in the qualifying order for that class.

7.7.8 Uneven Number of Boats. If there is an uneven number of boats in a class, a Bye Run is awarded to the number one qualifier in each class.

Bye Run - is earned whether by qualify standing or

round win. You Do not need to take a Bye Run but will still earn round points. As a courtesy, please inform ramp staff if not running bye. If Bye Run is not taken the boat will be paired for next round as slowest boat. If a boat's opponent fails to report at the launch ramp a Legal Single will be awarded.

Legal Single - you must run the pass. You must Cross the starting line and clear course to earn points.

7.7.9 **Foul Start (Red Light)**. During Eliminations, a foul start occurs when a boat crosses the start ing line prior to receiving a solid green light, activating the red light in that lane and eliminating that boat. If both boats red light - the boat with the greater red light is eliminated. A foul start on a bye run or legal single run has no effect on the run whatsoever.

7.7.10 **Breakout**. Breakouts apply to the Pro Modified class as well as all Sportsman and Bracket classes. A breakout occurs when a boat runs an E.T. that is quicker than the index for the class in which that boat is competing. A breakout on any side by side run during eliminations will eliminate the boat from further competition. If a double breakout should occur, the boat which breaks out of its E.T. bracket by the least amount shall be declared the winner of that round. A breakout on a bye run or legal single run has no effect on the run whatsoever.

7.7.11 **Identical E.T.'s - Brake Out the Least**. During eliminations, if two or more boats record identical E.T.'s, during a round, the boat registering the lowest R.T. will be considered the quickest for the purpose of lane selection in the next round. If there are identical E.T.'s and R.T.'s, the boat recording the E.T. first would be considered the quickest.

7.7.12 **Class Win - Single Boat**. In order to win a class when there is only one boat registered therein, the boat must make a qualifying attempt during qualifying. During eliminat ions, the boat must make a single run. One boat classes will be run at the discretion of the sanctioning division or chapter.

7.7.13 **Class Winners**. All final round class winners may have the appropriate official at the out ramp check their gasoline, alcohol, or nitre-met hane mixture as soon as the boat comes out of the water. If water injection is used, a water sample will also be taken. If requested, an engine oil sample may be taken. Cubic inch displacement is also subject to being checked. See also "Racing Fuels/ Fuel Samples" for further information.

7.7.14 **Grounds for Eli minat ion**. Elimination means that the boat is no longer in the competition program. Grounds for elimination are as follows:

7.7.14a Failure to report to the launch ramp.

7.7.14b Failure to launch or drive to the starting line holding rope.

7.7.14c Safety, such as, but not limited to, hooking the holding rope, crossing the center line or outer boundaries of the race course, or hitting any course equipment while under acceleration or own power. Centerline and outside buoys may be touched, deflating or unmooring will result in elimination. **Any time a sensor or tower requires realignment after a run constitutes "hitting any race equipment "** In the instance that where a competitor crosses the center line or outer boundary of the race course beyond his normal race course, said boat will advance to the next round (as long as he **is the winner of that round) but will forfeit round win points for that round. Breakout of more than 3/IOs in competition is immediate elimination.**

7.7.14d Failure to start, leave the starting line holding rope, or cross the starting line under the boats own power within five (5) seconds after the green light in his/her lane, said boat shall be eliminated. Reaction time will determine the five second rule. If both boats fail to cross the start line within five (5) seconds of the green light, the winner will be determined by the previous round ET, or qualifying position, if there is no previous round.

7.7.14e Foul start.

7.7.14f Breakout. In the event of a double breakout, the boat breaking out by the least amount will be the winner (Pro Modified, Sportsman, and Bracket classes only).

7.7.14g Failure to cross finish line. **If** both boats fail to cross the finish line, and no other grounds for elimination are committed by either boat, the winner will be determined by reaction time.

7.7.14 h Losing a valid elimination round.

7.7.15 Grounds for Disqualification. Disqualification means that the boat is no longer in the competition program and may not be allowed back into competition for any reason whatsoever for the remainder of the event at which the infraction occurred. Grounds for possible disqualification are as follows:

7.7.15a Violation of the Substance Abuse Policy as defined elsewhere in this rule book.

7.7.15b Failure to comply with the rules and/or regulations which are contained in this rule book, or failure to follow proper directions of race working officials.

7.7.15c Unsportsmanlike conduct, including, but not limited to, abusive language, gestures,

threats, and physical assault.

7.7.ISd Running down the race course when the solid red lights are illuminated (indicating that the course is closed).

7.7.ISe Starting or attempting to start a boat's engine while under tow on the water.

7.7.14f Approaching another boat or object at an unsafe speed or angle, or any other action or practice deemed unsafe by any official.

7.7.ISg Disconnecting, overriding, substituting, or attempting to defeat any safety related rule or item required to pass the pre-race safety inspection.

7.7.1 Sh Any open boat running 5.70 seconds on a 1000' course.

7.7.1 Si Demonstrative or "show-boating" actions by a driver (such as removing hands from the steering wheel and waving or gesturing to the crowd) while under full throttle on the race course.

7.7.ISj Any action(s) which is disruptive or intended solely to impede the normal progress of the racing program, such as, but not limited to, blocking the tow vehicle traffic pattern, blocking the boat ramp(s), or any type of disruption at the timing tower, etc.

7.7.ISk Failure of the driver of a tow vehicle to remain with the tow vehicle while the boat is in the water and/or being towed to or from the boat ramps.

7.7.151 Allowing an unlicensed driver to operate any motorized vehicle and/or mini-bike at the event site unless authorized by an official of the sanctioning division or chapter. Unlicensed vehicles may not be operated after dark unless equipped with lights. Check with each event site for rules regarding use of motorized pit vehicles. At no time shall these event site rules negate more stringent rules set in this book.

7.7.ISm Any boat that fails to pass a safety inspection after damage has occurred to the hull.

7.8 First or Worst

The primary objective of each race is to have one winner and one loser. Should a double rules infraction occur on the same run, the driver committing the major (or more serious) infraction shall be eliminated; the driver committing the lesser offense shall be reinstated as the winner of that round of eliminations. Items appearing above under "Grounds for Elimination" and "Grounds for Disqualification" are listed in the order of their seriousness, with the most serious listed first, and

the least serious listed last. All items under "Grounds for Disqualification" are considered more serious than those found under "Grounds for Elimination."

7.9 Incomplete Race

In any class that does not complete eliminations due to any circumstances, such as inclement weather, winners will be determined as follows

7.9.1 Canceled Before First Round. If the race is canceled before the first round of eliminations is started, the winner of each class will be chosen using the lowest legitimate elapsed time (E.T.) recorded in qualifying . No purse will be paid.

7.9.2 Canceled During First Round. If any class of boats is unable to complete the first round of eliminations (due to round scheduling) although other classes did, the winner of said class will be determined by the lowest legitimate elapsed time (E.T.) recorded in qualifying. If there are identical E.T.'s, the boat with the lowest R.T. would be the winner. If there are identical E.T.'s and R.T.'s, the boat recording the R.T. first would be the winner.

7.9.3 Canceled After First Round. If the race is canceled before the final round but after the first round of eliminations of a particular class has been completed, the winner of said class will be determined by the lowest legitimate **live** elapsed time (E.T.) recorded during the most recent fully completed round of eliminations for the class. If identical E.T.'s: see above rule. If the first round is completed fifty (50) percent of promoter's advertised purse will be paid. If semi-final round is completed one hundred (100) percent of the promoter's advertised purse will be paid.

7.9.4 Starting/Timing System Malfunction. If during eliminations, a serious malfunction of the starting and/or timing system were to occur, and it obviously could not be corrected or repaired in a timely fashion so as to complete the eliminations program, the following guidelines (subject to any deviations mandated by local conditions and approved by the Sanction Supervisor) will be used to conclude the racing program:

7.9.4a If a failure of the starting system makes it impossible to electronically determine foul starts, officials **will** visually observe the starting line for foul starts. Open boats may not leave the starting line holding rope until the green light is illuminated; capsule boats may not close the capsule lid and subsequently leave the starting line holding rope until the green light is illuminated.

7.9.4b If a failure of the timing system makes It Impossible to electronically pick each race winner, officials will visually observe the finish line, and they will declare the winner of each run.

7.10 Problems & Protests

7.10.1 Filing. All problems as well as protests should first be presented to the class/hull rep, who in turn will present the problem or protest to the Sanction Supervisor. If the class/hull rep is unavailable or is a party to the problem or protest, the problem or protest should be presented directly to the Sanction Supervisor. All protests must be submitted in writing on an official Protest Form (available from the Sanction Supervisor). Protests may only be made by an owner or driver in the same class as the boat or driver being protested. Protests should be factual, specific, and as complete as possible . The protest must be submitted no later than fifteen (15) minutes following the incident which caused the protest, or fifteen (15) minutes following the last time that the boat or driver being protested comes out of the water, whichever occurs first. All protests must be accompanied by the required fee in cash (see Appendix C). Once a class elimination has been completed, only the winning boat or driver may be protested. If a protest is lodged against the winning boat, all fuel and fluid checks must also be obtained from the class runner-up . Should the protest against the winning boat be sustained, the boat that was last defeated by the violator shall be declared the winner , assuming that he is found to be legal.

7.10.2 Equipment. Protests for alleged illegal equipment must be filed as described above under "Filing" and accompanied by the required fee in cash (see Appendix C).

7.10.3 Engine. Protests for alleged illegal or oversized engines which will require an engine tear down must be filed as described above under "Filing" and accompanied by the required fee in cash (see Appendix C). The cash is to be deposited with the Sanction Supervisor. The owner of the boat being protested may designate the person(s) that he wishes to perform the physical tear down, which is to take place immediately following the completion of the class in which the alleged offender is competing . An engine tear down, as the result of a protest, shall include the removal of at least one (1) cylinder head and assembly. The Sanction Supervisor shall oversee or designate another official to oversee the engine tear down. The protester is strictly prohibited from being present during the tear down and from being allowed to inspect the engine once it is torn down. Upon its completion, the Sanction Supervisor, along with other officials or advisers (as needed), shall evaluate the protest. If the protest is sustained, the protest fee, less the compensation for engine tear down (see Appendix C), shall be returned to the protester:- Should the protest be disallowed, the protest fee, less the compensation for engine tear down, shall be given to the party who was protested . The compensation for engine tear down will go to the sanctioning division or chapter for payment to the person(s) who performed the actual engine tear down.

Formula for Engine Cubic Inch Displacement

Bore x Bore x Stroke x .7854 x 8
(assumes 8 cylinder engine)

7.10.4 Fuel/Oil/Water. Protests for suspected infractions concerning gasoline, alcohol, nitro-methane mixture, water used in water injection systems, or additives in engine lubricating oil must be filed as described above under "Filing" and accompanied by the required fee in cash (see Appendix C).

7.10.5 Procedures. Protests for alleged violations of race procedures by any officials must be filed as described above under "Filing." No fee is required.

7.10.6 Refusal. Refusal to allow any fuel or fluid samples to be taken has the same force and effect just as if the sample had been taken and found to be illegal, and the same fines and/or penalties apply. Refusal to allow an engine tear down, if protested, has the same force and effect just as if the engine had actually been torn down and found to be illegal or oversized, and the same fines and/or penalties apply (see Appendix C).

7.10.7 Protest Disallowed. Any protest which is disallowed or found to be invalid shall result in no fines and/or penalties being imposed. Fees for fuel/oil/water protests will be retained by the sanctioning division or chapter. Fees for engine and/or equipment protests will be disbursed as outlined above under "Engine."

7.10.8 Protest Sustained. Any protest which is sustained or found to be valid shall result in fines and/or penalties being assessed against the offending competitor(s). Penalties will be determined by the Board of Directors of the sanctioning division or chapter. They may range from a verbal warning or a written reprimand up to a suspension from racing at sanctioned events. Fees for fuel/oil/water protests will be retained by the sanctioning division or chapter. Fees for engine and/or equipment protests will be disbursed as outlined above under "Engine."

7.10.9 Protest Reply. The decision as to how any protest will be handled rests with the Sanction Supervisor. All formal written protests, filed in accordance with the regulations contained herein, will be reviewed by the entire Board of Directors of the sanctioning division or chapter, who shall be held directly accountable for a formal reply. Said reply shall be made as soon as possible.

7.12 Retention of Boats & Parts

By virtue of registering any boat at a sanctioned event, the participant thereby grants the KENTUCKY DRAG BOAT ASSOCIATION, the sanctioning division or chapter, and their assigns the full and unconditional permission to collect and

retain boats and parts of boats owned by or in the possession of said participant, including such boats and parts of boats which have been involved in an accident when the KENTUCK DRAG BOAT ASSOCIATION or the sanctioning division or chapter determines in its discretion that such actions are necessary incidental to the investigation of an accident, the inspection or testing of such boats or parts of boats, or for any other purpose. Upon conclusion of the testing and inspection, all boats and/or parts of boats will be returned to the owner(s). No sponsor, promoter, rescue personnel, diver, other participant, or spectator shall have any rights whatsoever to any boat, engine, equipment, or parts thereof which are recovered and retained pursuant to the foregoing.

RULE 8.0

BOAT SAFETY EQUIPMENT - GENERAL

8.1 **General**

8.1.1 All hulls must be in good, sound condition, fully capable of withstanding the rigors of drag boat racing. All air tanks, batteries, cables, fuel pumps, fuel tanks, impellers, mountings, paddles, propellers, propeller shafts, seats, steering assemblies, struts, rudders, etc. must be both firmly secured and in good operating condition. In addition, any boat participating in a sanctioned event must be presentable in appearance at all times. Those with objectionable or obscene names, graphics, or pictures will be rejected by the Safety Inspector. Likewise, the appearance of owners, drivers, and individual crew members is of equal importance, and is subject to the same considerations. In case of a disagreement, all members of the Board of Directors/Competition Committee present at the event will immediately meet and decide the issue. Their decision will be final.

8.1.2 All boats which are to be registered to compete at a sanctioned event in any class must have the following items inspected by the Safety Inspector (or his assistant). All determinations as to whether or not any piece of equipment, including both the driver's as well as the boat's, complies with these safety requirements shall be at the discretion of the Safety Inspector. Any boat which has passed safety inspection at any event is still subject to re-inspection or random inspection at the discretion of the Safety Inspector at that event. Likewise, the boat remains subject to inspection at any subsequent event(s).

8.1.3 **Clutch and Bell Housing** (Refer to Rule 10.22.)

8.2 **Bilge Pump**

8.2.1 All open boats must have an electric bilge pump.

8.2.2 Capsule boats must have a solid state water detection switch (manual type not allowed) which may or may not activate the pump but must turn on a warning light in the capsule in plain view of the driver. Switch must have an external checking device and be placed to turn on at approximately two (2) inches of water level. (Johnson Pump Model 36303 Ultima switch, meets this criteria).

8.2.3 All automatic pumps must have a manual over ride switch.

8.3 **Blower (Supercharged)**

8.3.1 Top Fuel Hydro: Supercharger: Required :

Roots-type, Hi-Helix or Helix. Manifold burst panel meeting SFI Spec 23.1, plus restraint system meeting SFI Spec 14.2 mandatory . Supercharger restraint straps must be covered. Screw-type superchargers prohibited. Remote-mounted supercharger prohibited . Variable multi-speed supercharger device prohibited.

8.3.2 Roots Type - Maximum size 14-71; maximum rotor case length 19 inches; maximum case width 11.250 inches; maximum rotor cavity diameter 5.840 inches; minimum front plate thickness .250 inches; minimum rear plate thickness .300 inches. Rotor helix angle may not exceed four (4) degrees per inch. Maximum overdrive allowed is seventy percent (70%).

8.3.3 Roots Type High Helix. Must adhere to same minimum/maximum case dimensions as well as maximum rotor cavity diameter allowed for standard Roots type supercharger. Rotor helix angle may not exceed six and one half (6.5) degrees per inch. Maximum overdrive allowed is seventy percent (70%).

8.3.4 Screw Type. Allowed only on gasoline or alcohol motors in sportsman, Pro mod, and TAH classes only. Maximum case length 16 inches; maximum case width 16 inches; minimum case and front plate thickness .250 inches; minimum rear plate thickness .300 inches. Screw superchargers with a rotor diameter in excess of eight and one half (8.5) inches will be limited to a maximum overdrive of sixty percent (60%); those with a rotor diameter of eight and one half (8.5) inches or. Under no circumstances may a screw type supercharger overdrive exceed the manufacturer's SFI test maximum. A supercharger burst panel is required in addition to a manifold burst panel. Overdrive limits, as determined appropriate by the KENTUCKY DRAG BOAT ASSOCIATION, (based upon performance criteria) are subject to adjustment at anytime.

8.3.5 Aluminum manifold mount studs are required with all superchargers.

8.3.6 Variable multi-speed supercharger devices are prohibited regardless of supercharger type, in all Pro Classes. In addition, remote mounted superchargers as well as mechanical overdrive devices will not be permitted.

8.3.7 TAH Supercharger

PSI "C-Case" 1.92 999 Single Propeller - AJ
PSI "C-Case" 2.25 Dual Propeller
PSI "D-Case" 2.06 Single/Dual Propeller -AJ
Whipple 1.60 Single/Dual Propeller -AI

8.4 Blower Burst Panel (Supercharger Burst Panel)

A manifold burst panel meeting "SFI 23.1" specification is required on all supercharged engines using nitro-methane as fuel.

8.5 Blower Restraints (Supercharger Restraints)

All blown (supercharged) engines must use SFI approved blower restraining devices as Indicated below:

Engine Fuel	Supercharger	SFI Device
Top Fuel	Roots/High Helix	14.2 Bag
Blown Alcohol	Roots/High Helix	14.1 Straps
Blown Alcohol	Screw	14.21 Bag
Blown Gas	Screw	14.21 Bag
Blown Gas	Roots/High Helix	Not Req'd

All restraining devices must be secured and in place at all times when the motor is running. Blower restraining devices are required to be returned to the manufacturer every four (4) years from date of manufacture for recertification/dating. It is the responsibility of the owner or driver to ensure that the new date tag was sewn into the device after recertification. TFH, TAH and TAF blower restraints must be re-certified every two (2) years.

8.6 Blast Plate/Cavitation Plate Attachment

In Top Fuel Hydro, Top Alcohol Hydro, Blown Alcohol Flat, Pro Modified and Pro Outlaw classes, bolts must be attached no closer to the leading edge of the plate than the diameter of the bolt used. (i.e.) (3/8 bolt 3/8 inch, 5/16 bolt 5/16 inch. etc.) Measurement will be taken from the leading edge of plate. When flat head bolts are used, the measurement will be taken from the leading edge of the countersunk taper to the leading edge of the plate. Bolts may be attached no further than 1 inch from the leading edge of the plate. Measurement to be taken from leading edge of plate to leading edge of hole. Maximum spacing of bolts is three (3) inches on center.

8.7 Bolts

All bolts on critical installations such as, but not limited to, drive train, engine mounts, steering, rudders, etc. must have a minimum of one thread showing through the nut or nylon locking device. Bolts shall be of sufficient grade to provide adequate strength for the application. Ungraded bolts are not permitted.

8.8 Bow Eyes

All boats shall be equipped with a bow eye located at the bow (front) of the boat. All pickle fork type boats shall also have installed an additional towing eye on the inside front tip of the left sponsor or the extreme forward center point of the boat.

8.9 Boat Number/Class Designator

All boats must have two (2) sets of racing numbers on each side of the boat that are contrasting in color to the color of the boat. Only numbers are allowed; alpha/numeric combinations are not permitted. One set must be a minimum of three (3) inches high and located above the level of the engine's valve covers. The other set of numbers must be on the sides of the boat itself and must be a minimum of six (6) inches high. However, only one set of numbers is required on a boat if the numbers are at least four (4) inches high and located above the level of the engine's valve covers on the sides of the capsule, the cowling behind the capsule, or the carburetor scoop, etc. Each boat number will also include a letter assigned to each member's home association. The letter will be placed after the number and will be a minimum of one and one half (1 ½) inches tall and be of the same color as the boat number.

ADBA-A

CBDA-C

KDBA-K

SDBA-S

ONETIME-X

Any boat displaying a number which is already assigned to another boat, or displaying a number which has been retired, must obtain a new number at registration, and change said number on the boat prior to entering the water. Failure to do so will result in the boat forfeiting any qualifying points which it would normally have earned. Failure to change the number prior to eliminations will result in the boat being disqualified at the ramp when the first round of eliminations is called. When a racer attends a race outside his home division, if requested by the sanctioning division, he must change his number. The class designator (i.e., TFH, TAH, PM, etc.) must also be displayed on both sides of the boat. It should be in close proximity and proportionate in size to the boat number which is located above the level of the engine's valve covers.

8.10 Tow Vehicle - Trailer Number

The boat number and class designator (minimum three [3] inches high) must be displayed in white on the passenger side of both the front and rear glass of all tow vehicles.

8.11 Battery Disconnect Switch

An electrical power cut off switch (one only) must be installed near the batteries and be easily accessible from outside the boat. This cut off switch must be connected to the positive side of the electrical system and must stop all electrical functions. The "off" position must be clearly indicated with the word "OFF". If the switch is a push/pull type, "push" must be the action for shutting off the electrical system. (Pull to turn it on.) Any rods or cables used to activate the switch must be a minimum of 1/8th diameter. Plastic or key switches prohibited. The power cut off switch must be placed in a location so if there's a fire in the engine, driver's area or compartment, rescue crew or track officials can reach it. Location must be clearly marked by decal furnished by KDBA.

8.12 Chrome Plating

Chrome plating or coating that will not allow the ability to crack check any of the roll cage or underwater hardware is not permitted on any boat in any class whatsoever.

8.13 Crankcases Catch System

All boats must have some type of catch can or vacuum recovery system to reserve any blow-by fluids that may vent out of the engine crankcase and prevent any oil/fuel from entering the water. If the system goes to the headers, it must employ an oil separating device.

8.14 Decals

KDBA and supporting sanction body logo decal shall be affixed to the exterior surface on each side of all boats. Said decal shall be mounted in close proximity to the cockpit area and located in such a position that it is clearly visible when viewed approximately fifteen (15) feet from the boat. As required by Rescue, decals indicating location of battery cutoff switch and external capsule release shall be displayed. (available from Safety and Tech).

8.15 Drive Line Cover

8151 All open inboard V-drive boats must utilize a 360 degree driveline cover. A driveline is described as a drive shaft of any length which has u-joints attached, or a splined coupler. The cover must be constructed from one quarter (1/4") minimum thickness aluminum, or one eighth (1/8") minimum steel. No perforations are allowed, and must be designed, constructed and installed in such a manner that it will maintain total structural integrity in the event of failure of the drive shaft or attached u-joints.

8152 No cover is required with a splined coupler, if installed on a capsule or jetboat.

8153 Jet boats may use a 360 or 180 degree cover, a loop as described in the following section, or a device that will deter the drive line from exiting the boat in case of failure . No cover is required if the drive line is covered by the hull or transom.

8154 Cast iron flywheels will not be allowed unless SFI certified or has a SFI approved bell housing.

8.16 Drive Line Loop

Jet boats utilizing a drive shaft with one or two U-joints may use a drive line loop instead of a drive line cover. The loop can be made of the following materials:

1. 7/8 inch x .065 wall welded steel tubing
2. 1/4 inch x 2 inch wide flat steel
3. 1/4 inch wall steel tube x 2 inch wide

All of the above must be three hundred sixty (360) degrees around the shaft, located and mounted within six (6) inches of the U-joints. For shafts longer than fourteen (14) inches, two (2) loops must be used. All loops must be mounted securely through the stringers to support the shaft in the event of a U-joint failure. A round loop must be used so as to minimize the load on the loop. Maximum clearance around the shaft is to be one inch.

8.17 Engagement and Disengagement Device

All inboard propeller driven boats shall have installed a device making possible the engagement and disengagement at will of the propulsion device while the engine is running.

8.18 Fire Extinguisher

A fire extinguisher which is quickly and easily accessible, is required to be in the rear of all tow vehicles used during any sanctioned event. Said fire extinguisher must have a minimum five (5) pound capacity with a 10 B.C. (U.L.) rating and must be fully charged as indicated by a visual gauge on the fire extinguisher. Although not required, it is permissible to have another fire extinguisher (securely mounted) in the boat itself. The size of this second fire extinguisher **will** be per the owner's discretion.

8.19 Flywheel Cover

All inboard powered boats must have a three hundred sixty (360) degree flywheel cover made of production cast aluminum (or the equivalent).

8.20 Fuel Shut-Off Valve

All fuel injected boats must have a quick action push/pull fuel shut-off valve, the valve control must be in front of and within

easy reach of the driver. If the valve control is installed within a capsule, see Capsules/Breakaways for restrictions on the control mechanism. The valve itself must be installed in the fuel line between the main fuel pump and the fuel injectors.

8.21 Harmonic Balancer

Two-piece cast iron (stock type) harmonic balancers must be enclosed within a shield made of either one quarter (1/4) inch minimum thickness aluminum or one eighth (1/8) minimum thickness steel. The design, construction, and installation of the shield must be such that it will afford three hundred sixty (360) degrees of protection while maintaining total structural integrity should the balancer inadvertently explode. SFI approved aftermarket balancers do not require a shield.

8.22 Holding Rope Deflector

A holding rope deflector is required on all boats in order to deflect the holding rope over the highest point of the boat and provide clearance from the widest point from the driver's seat rearward. The design of the deflector should be such that a driver may simply drop the holding rope behind his helmet as he proceeds away from the rope, and the rope should not subsequently snag, hang, pull, or catch any part whatsoever of the boat, engine, carburetor scoop, injector hat or tubes, flat bottom wing, miscellaneous hardware, and so forth. On open boats, the holding rope deflector must be solidly attached at both ends as well as attached or supported at the highest point behind the driver with no protruding points to catch the holding rope or to injure the driver in the event of an accident. The deflector must extend rearward at approximately a forty-five (45) degree angle, which should be sufficient to deflect or guide the holding rope up, over, and around whatever is located behind the driver.

Construction is to be of 3/4 inch O.D. (outside diameter) x .049 inch wall thickness tubing or any material or combination of materials having the same structural strength and integrity. Capsule boats utilizing a holding rope deflector between the capsule and the engine must employ a slip joint at one end so the capsule and engine are not bolted together by means of the deflector. Vinyl plastic encased wire rope may be used between the engine and wing on flat bottoms equipped with a wing. Said wire rope must be a minimum of one eighth (1/8) inch in diameter, excluding the vinyl plastic covering.

8.23 Impeller

All Professional and Sportman class jet boats must use either stainless steel or bronze impellers only. In addition to stainless steel or bronze, Bracket E.T. classes will also be permitted to utilize aluminum impellers. However, all classes are prohibited from using any impeller which is designed and manufactured using either two piece or multiple piece construction. Only

impellers which are manufactured as a solid one-piece unit will be accepted.

8.24 Impeller Release Device/Pressure Release System

T.E., P.E., and QE class jet boats are required to use either a ratchet type release device or a pressure relief valve . The pressure relief valve is required on jet boats that run 6.99 sec. or quicker . Both mechanisms may be used. The pressure relief valve must be designed to open automatically case of engine or jet drive failure. Once activated, the valve must remain open until such time as the boat has come to a complete stop, and the engine shut down. Valves that reset pneumatically or electronically, may do so with the boat at rest and the engine shut down. Manual resetting must be done when the boat is back on the trailer . The valve piston size must be a minimum of four (4) inches in diameter, resulting in a minimum of thirteen (13) square inches of unrestricted exhaust opening. The pressure relief valve, if used, must be installed on the intake side of the jet pump bowl. A 'tattletale' pressure gauge (0-200 psi) must be installed on the suction pressure tap used to sense high pressure to automatically open the valve and shall be mounted as close to the packing nut as practical. In lieu of a pressure gauge a data collection system that records pressure during automatic activation may be used. A manual override button must be installed on the steering wheel of the boat. If only a pressure relief is used, it must function properly on each pass.

8.25 Kill Switch

All open boats must have an electrical ignition kill switch device which will immediately and automatically shut off the engine in the event the driver is thrown from the driver's seat. All open fuel injected blown boats utilizing nitre-methane for fuel shall be equipped with two automatic kill switches - an electrical ignition kill switch as well as a fuel shut-off device. The electrical kill switch shall be mounted directly alongside of or in front of the driver's seat, and within an arm's length of the driver. The automatic fuel shut-off device shall be installed in the main fuel supply line between the fuel pump and the injectors. Both the electrical kill switch and the fuel shut-off device should be mounted and the release cords routed so as to disconnect should the driver's posterior move more than eighteen {18} inches in any direction from the driver's seat. Any kill switch device that is attached to the driver must have a maximum breaking point of fifty (50) pounds within a maximum distance of six (6) inches from the dri've.r

8.26 Paddle

All open boats, at the option of the driver, may have a paddle, securely mounted, within easy reach.

8.27 Propeller

No chrome plated, brass, or aluminum propellers will be allowed on any flat bottom, hydro, or outboard boat. The propeller must fit on the propeller shaft in such a manner that the propeller hub is within three quarters (3/4) of an inch of the strut barrel. Propeller retention must include a cotter pin, one eighth (1/8) inch minimum diameter, through the shaft, with a lock nut or double nut in front of the cotter pin, or a castle nut indexed by the cotter pin.

8.28 Propeller Shaft

The minimum diameter for the propeller shafts (prop shafts) for all inboard powered hydro's and flat bottoms shall be as follows:

<u>Class</u>	<u>Prima01 Shaft</u>	<u>Seconda01 Shaft</u>
TFH	1-1/4 inch	1-1/4 inch
TAH	1-1/8 inch	1-1/4 inch
TAF	1-1/8 inch	1-1/8 inch
PM	1-1/8 inch	1-1/8 inch
All Others	1 inch	1 inch

8281 If a two-piece prop shaft is utilized, the coupler used to connect the two pieces together must meet the following criteria (depending on the type of coupler used):

8.28.1a. Through Bolt Coupler - Bolt must be indexed into propeller shaft. The bolt must be the same size as the hole in the coupler

8.28.1b Split Coupler with set screw retainer. Propeller shaft must be dimpled with a drill bit that will fit into the set screw hole in the coupler the full depth of the drill bit point. The set screw must be secured in the hole.

8.29 Propeller Shaft Release (Whirlaway)

All inboard powered flat bottoms and hydro's must be equipped with a propeller shaft (prop shaft) release mechanism installed in the boat's drive line.

8.30 Pump Leader

All jet boats are required to have the pump leader secured with a minimum of four (4) size five sixteenths (5/16) inch grade 8 steel bolts. A minimum of two (2) of the bolts must be drilled completely through and secured with nuts. Flathead stainless steel bolts are not allowed.

8.31 Radio Receiver

All drivers must have 'a listen only' radio receiver that tunes into the rescue, starter, and tower race control frequency.

8.32 Rudder

Rudders are not required on jet boats. No chrome plating or coating that prohibits the ability to crack check rudders will be permitted on any boat . Steel rudders for TFH (and dual prop boats) shall be a minimum of three quarters. 3/4" inch thick at the clamshell All other Pro Class (except PM) boats shall have a minimum five eighths 5/8" inch steel rudder. Pro Mod and Sportsman class boats shall have a minimum half 1/2" inch steel rudder. All rudders must extend to at least the bottom tip of the propeller when said propeller is installed on the boat and positioned in a vertical manner . Rudders on any outboard running in a class with an index of 8.99 or quicker shall be a minimum of three eighths {3/8} inch thick at the clamshell, and the clamshell itself shall be a minimum of three eighths {3/8} inch thick on each side of the rudder. The rudder must extend a minimum of one (1) inch below the bottom tip of the propeller when said propeller is installed on the motor and positioned in a vertical manner. All boats using a through-the-hull rudder are required to utilize a safety collar which will prevent the rudder from disengaging itself from the boat.

8.33 Rudder Clamshell

Boat rudder clamshells shall meet the minimum dimensions as listed in Appendix G. {No "lightened" steering hardware in TAH}.

8.34 Safety Collar

All inboard powered flat bottoms and hydro' s must utilize a safety collar on the propeller shaft (normally directly in front of the prop shaft log) which will prevent the propeller shaft from moving backward. In addition to the aforementioned safety collar, all hydro' s must also utilize a two-piece split steel safety collar on the prop shaft under the boat. This second collar shall be located at a maximum distance of one half (1/2) inch directly forward of the main strut.

8.35 Safety Chain

All trailers must have and use a safety chain .

8.36 Steering

8361 1 All boats using open cable steering must use a minimum three (3/16) inch cable with cable ends at turnbuckles double clamped and taped .

8362 Jet boats may use one eighth (1/8) inch cable if the cable is exposed only from the transom outward.

8363 Any sportsman outboard with an ET index of 8.99 (1320') or 6.99 (1000') or quicker, utilizing a hydroplane hull may not use the motor to steer . The motor must be locked

in a straight ahead position and steering accomplished by a separate rudder assembly.

8364 On capsule boats the steering box must be mounted free of the capsule utilizing a bracket to prevent rotation of the assembly. A slip joint must be employed to connect the steering shaft to the steering box. A minimum of two safety collars must be installed to prevent the steering shaft moving aft.

8365 ADVISORY On all capsule boats. A plate of three eighth (3/8) inch thick, plus three (3) inch H x four (4) inch W shall be installed on the front of the cage or on front of the capsule shell (either inside or outside), around the steering hole to prevent the steering rod from damaging the front of the capsule .

8.37 Throttle

Throttle butterflies (carburetor, injector, throttle body, etc.) must be manually operated by the driver's foot (or hand in an approved handicapped application) via direct cable connection. No electronic, pneumatic, hydraulic, OR ANY OTHER MECHANISM, may be installed that can influence or regulate the flow of air into the engine.

In addition, no devices may be used to alter the application rate of the throttle pedal. Butterflies are defined as: any device that changes the flow of air into the engine. Nothing will be installed on the pedal assembly that will prevent the butterflies or pedal from returning to idle when pedal is released.

8.38 Throttle Return Spring

All boats utilizing carburetors or fuel injectors must have one quick action return spring attached to that part of the throttle plate lever which is connected to the butterfly shaft arm per carburetor. Two quick action springs are **required** on single carburetor/injector systems. All boats using the "bug catcher" type injector hats must have a spring on both sides of the hat . Throttle spring ends must be looped and attach between a solid point and the throttle plate lever, avoiding the cable attach point.

8.39 Throttle Stop

All boats which are equipped with a foot operated accelerator pedal must incorporate a functional mechanical stop in the pedal mechanism which will limit the forward motion of the pedal. The stop must be positioned so as to prevent the throttle linkage from passing over center and thus sticking or locking in a full open throttle position.

RULE 9.0

DRIVERS SAFETY EQUIPMENT- GENERAL

9.1 Ballistic Shorts

All open boats and PWC's running over 70 mph will be required to wear ballistic shorts.

9.2 Helmets

All crash helmets must be proper fitting and meet as a minimum either the "SNELL specification, "SFI 31.1" specification (open face), or "SFI 31.2" specification (full face). All helmets will be within twelve (12) years of the SFI/Snell rating. A label indicating the rating must be permanently attached to the inside of the helmet, or the rating must be stamped into the helmet itself. All helmets must fully cover the head, neck, and ears. With the exception of the driver's boat being under tow, helmets must be worn by drivers at all times while on the water.

Helmet Expiration Date

*Snell	2007	1/1/2019
*Snell	2010	1/1/2022

***No 2005 "Snell" helmets allowed under any circumstances.**

9.2.1 PWC and River Racer DOT helmets allowed .

9.2.2 Capsule Helmets . Full face helmets are mandatory in all capsule boats, meeting Snell expiration dates listed, utilizing either a neoprene neck sock/sealed face shield or a or a full-face helmet utilizing a fighter style mask with an ambient/on demand system. A standard open face helmet used with a normal SCUBA mouthpiece will not be permitted.

9.3 Helmet Head and Neck Restraints/Hans Type Device

9.3.1 Helmets must be held on with approved straps, commercially manufactured straps for the purpose of restraining the helmet and preventing its inadvertent removal. Helmet restraint straps must attach to a body harness. They must attach to helmet on the right side, left side and back for open face helmets full face helmets requires the same with front strap added. "Inflatable" type neck collars allowed but not what we recommend.

9.3.2 A Hans type style helmet restraint is acceptable in lieu of straps. If SFI rated, must comply with recertification dates.

9.3.3 Restraints are required in River Racer class or PWC's that run over 70 mph.

9.4 Neck Collar/Hanes Type Device

Capsule boat drivers must wear, while on the water, a commercially manufactured foam neck collar and/or Hans type

device designed for racing. Said collar must meet "SFI3.3" specification. Either a 360 degree donut type or a horseshoe type may be used. Modification according to the manufacturer's recommendations to fit a driver's helmet and neck/shoulder spacing is permitted. The collar must be worn in accordance with the manufacturer's recommendations. Hans type device may substitute for a neck collar. PWC will be required to wear a neck collar or helmet restraints, unless the driver is wearing a racing type life jacket, helmet restraints will then be required. **No "inflatable" type neck collars allowed.**

9.5 Eye Protection

All drivers, while on the water, must wear approved eye protection made with safety glass or a flexible, shatterproof material which is commercially manufactured for use in racing. Either goggles or full-face shields are acceptable. No sunglasses will be permitted.

9.6 Visual Aid

At the time of the driver's equipment inspection, the driver must produce either his state driver's license or Competition Driver's License in order to verify whether or not visual aid is needed to drive. If visual aid is necessary, the driver's Competition Driver's License as well as his medical tag should so indicate. The driver must wear his proper visual aid at all times while on the water.

9.7 Driving Suit

9.7.1 PWC. Full cover shoes and socks, shorts/swim trunks that reach mid-thigh, and short sleeve t-shirt/jersey.

9.7.2 River Racer, Stock and Modified Eliminator. All drivers, while on the water, must wear long sleeved shirts, full legged pants, full cover shoes and socks. If using Alcohol, Nitro, or nitrous oxide, a fire-resistant driver suit, and gloves must be worn.

9.7.3 Professional, PE and TE. While engine is running on the water must wear approved driving suits which have been commercially manufactured specifically for racing. Said suits must be fire resistant, long sleeved, and have closed cuffs (either elastic or Velcro). All Professional and Sportsman drivers must have the SDBA patch sewn on the upper left or right portion of their driver's suit. If divisional sanctioning patches are available, they should be sewn opposite from the SDBA patch. Full cover shoes and socks must be worn.

9.8 Gloves

All open boats running alcohol, nitro, or nitrous oxide must wear fire retardant full fingered gloves, with fire retardant

labeling. (Note: outdated labels acceptable as SFI has amended recertification rule).

9.9 Life Jacket/Non-Capsule

9.9.1 All drivers in non-capsule boats must wear, while on the water, an approved life jacket. Capsule type life jacket suits are not allowed in open boats.

9.9.2 PWC, River Racer, drivers in boats that run 100 mph or slower - minimum of Coast Guard approved impact type jacket.

9.9.3 Drivers, except PWC, River Racer and Jr. Drag Boat, in open boats must wear an approved torso type life jacket which is commercially manufactured with a harness specifically designed for drag boat racing. Life Jackets must be worn at all times while the boat is on the water. All life jackets must be returned to an approved life jacket manufacturer for safety inspection and recertification/dating every two (2) years from date of manufacture for a parachute jacket and every three (3) years for a non-parachute jacket. *The driver is responsible for ensuring that a new date tag was sewn into the jacket after recertification.*

9.10 Life Jacket/Capsule

Minimum floatation , that will make the driver buoyant, must be worn. Note: a neck sock/sealed visor helmet is acceptable .

9.11 Knee and Shin Protectors

All capsule boat drivers are required to wear knee and shin protectors. These must be worn externally. The safety inspector may approve the removal of the knee protector if found that it interferes with the driver's ability to operate the boat.

RULE 10.0

CAPSULE BOAT SAFETY EQUIPMENT

10.1 Capsule Boats

Equipment - General. In addition to the items listed in Rule 8, Boat Safety, all capsule boats must have the following items and standards that are the minimum acceptable for each capsule and must be inspected by the Safety Inspector . All capsule boats must be towed to the holding rope, unless otherwise instructed to drive there by the Race director.

10.2 Capsules

Breakaway capsules, manufactured by SFI 36.1 (shell material), 36.2 (canopy material), and 36.3 (roll cage material advisory) approved manufacturers are required *in* all Professional classes. Capsules are also permitted in any Sportsman or Bracket class (if used, they must comply with the requirements noted herein). All capsules, regardless of manufacturer or type, must be fully enclosed, and designed using state-of-the-art technology in an effort to minimize serious injuries to the driver in the event of an accident. It shall be the responsibility of the boat owner to select the designer and/or manufacturer that best meets his standards for a high quality, crash worthy capsule. Any capsule that is involved in an accident must be recertified by a SFI certified Manufacturer or a SFI certified Capsule Inspector, before being allowed to participate.

10.2.1 ADVISORY. All capsules with a flat surface behind the driver are required to add a rounded addition, minimum one quarter (1/4) inch of thickness, fiberglass, Kevlar, carbon fiber or a combination thereof. The center extending a minimum of three (3) inches from back of the capsule.

10.3 Air Supply

A minimum 30 cu. ft. high pressure (3,000 P.S.I. system) or 50 cu. ft. low pressure (2,000 P.S.I. system) air tank is required for the driver. All air tanks must have current VIP/Hydro to pass tech. Boat number must be on bottle.

A quick release coupler must be installed in all air supply hoses between the first stage regulator and the second stage regulator, no less than twelve (12) inches, nor more than fifteen (15) inches from the driver's mask or helmet. The quick release coupler used must be one of the following Parker fluid connectors:

<u>Male/Female</u>	<u>Description</u>
SHI-63/SHI-62	Stainless steel non-locking
BHI -61/BHI -60	Brass non -locking

The male half of the coupling is to be installed in the air hose attached to the driver's regulator; the female half is to be

installed in the air supply hose coming from the air tank it self. All fittings and connections installed within the driver's air supply system must be mechanically crimped. No push-locks or hose clamps will be allowed. The SCUBA regulator must be permanently fixed to the driver's helmet with a maximum of three (3) inches of hose between the mask and regulator.

10.3.1 It is the driver's responsibility to ensure that his air tank has been refilled to 2,500 - 3,000 PSI for the high-pressure system, 1,850 - 2,000 PSI for the low-pressure system, or the equivalent thereof, prior to each run (qualifying as well as eliminations) . Random checks to determine if air tanks have been filled accordingly will be performed at the launch ramp prior to a boat being allowed to enter the water . Checks may also be performed at the out ramp to determine if acceptable amounts of air remain in a system after a run . See "Qualifying/Qualifying Attempt" as well as "Eliminations/Ramp Call/Launch" elsewhere in this book.

10.4 Air Bottle Mounting

Quick release brackets (either one quarter (1/4) inch minimum thickness aluminum or one eighth (1/8) inch minimum thickness steel, which will allow the air tank to be quickly and easily removed, must be permanently attached to the frame rails of the capsule. The quick release brackets must contain a three hundred sixty (360) degree cup type receiver at the base (or bottom) end of the air tank. This cup type receiver may be formed with a minimum one (1) inch wide strap, however it must be positioned and constructed in such manner that the upper edge of the strap is a minimum of one and one half (1-1/2) inches from the base of the air tank (measured lengthwise from the base of the tank) when the air tank is installed in the receiver . The neck of the air tank is to be held in position with a U-shaped bracket with a minimum one-quarter (1/4) inch diameter push only type quick release pin at the top which will prevent the air tank from moving in any direction when the tank is secured in the receiver. The upper bracket as well as the quick release pin must hold the air tank around the upper neck of the tank itself, not around the valve assembly which is screwed into the tank. Nylon straps with Velcro, hose clamps, and/or nylon cable ties are not acceptable .

10.5 Alignment Pins

All capsule roll cage lids shall have a minimum of four (4) alignment pins (2 per side), as indicated in Appendix L (Kasse capsules excepted) . On older capsules in lieu of forward pins, 4130 steel rods, 1/2," . minimum dia., or 4130 steel plates, minimum 1" wide X 3/16" thick, with a length that equals the outside diameter measurement of the cage upper rail bar plus the outside diameter of the lower lid tube. The rod/plate should be mounted on or near the forward cluster on the cage. A reinforcement bar, going from the lid rialto the hinge assembly is also accepted , as long as the design will inhibit the lower lid

rail from "springing inwards" during a barrel roll/side impact.

10.6 Breakaways

No one piece cables or hoses may be used between the capsule and the boat. One-piece throttle cables will be allowed if you use RBR type one-piece cable holder. All cables must utilize a breakaway device, with the break point positioned outside of the capsule. If a fuel shut-off valve is installed in the boat and said valve is controlled by an air system in lieu of a cable, the valve must be designed so that it **will** automatically close upon loss of air pressure. No plastic hoses or lines may be located in the engine area to activate the parachute or fire system.

10.7 Fire Control

"Cold Fire", Halon, CO2, Dry Chem, NAFS-111, or Fire X system with a ten (10) pound minimum bottle and visual gauge is mandatory on any boat utilizing nitro methane as a fuel. It is recommended in all other classes.

10.8 Floatation

All capsules must have sufficient floatation to keep the capsule floating even when completely filled with water. In addition, any boat in which a capsule is installed must have the maximum practical amount of floatation installed between the underside of the boat's deck and the inside of the hull. Said floatation must extend from the bow of the boat to the back of the capsule, and then within each gunnel to the rear of the boat. Floatation is not required across the transom area. The floatation used must be of a type specifically designed and manufactured to provide buoyancy in water. All floatation must be attached, bonded, or installed in such a manner as to render the floatation virtually impossible to remove. No bolts, clamps etc. may be used to hold the floatation in place. No peanut foam or block foam will be allowed. If cosmetic or protective panels are installed over the foam, they must either be removable or have inspection holes in them in order to visually verify the presence of the foam.

SEED/AGRAM

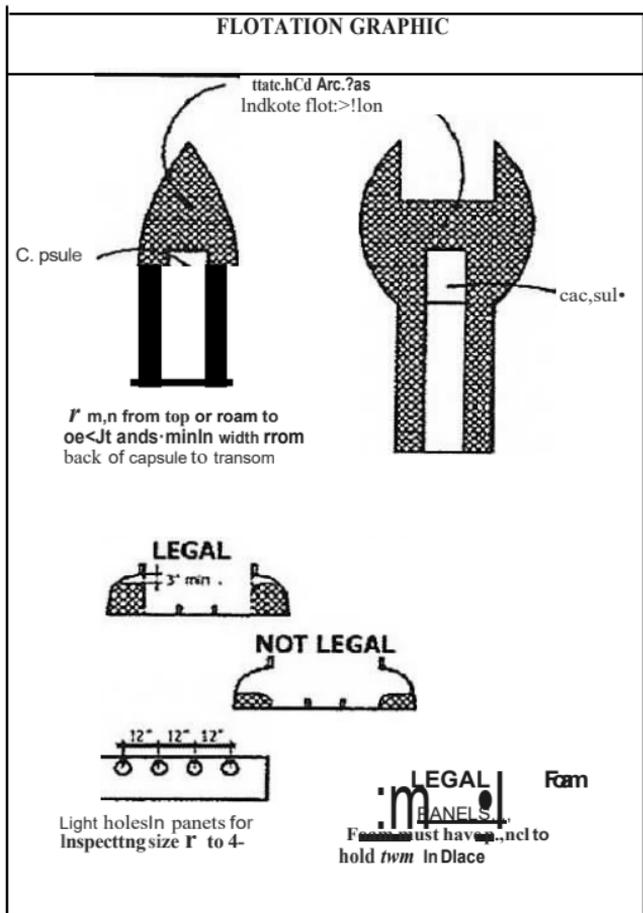

10.9 Interior

All brackets and levers should be mounted so as to prevent injury or interference to the driver in the event of a crash or emergency exit from the capsule. All interior items, such as the seat, must be securely attached to the capsule frame rails. Reinforcements should be used where needed to prevent excessive flexing which could result in the separation of components within the capsule. Foam padding which has a minimum one quarter (1/4) inch compression and meets SFI specification 45.1 must be installed around the head hoop as well as all head hoop supports in the roll cage assembly. At the driver's option, additional padding/guards may be installed to protect the shin, knee and foot areas. No tinting is permitted on the windshield (canopy) in order that divers may see into the capsule if it is submerged.

10.10 Latches Latch Pins

J latches are no longer approved. Door bolt action type or inverted over center type systems may be used.

Latch pins must be one-half (1/2) inch minimum diameter push only type with a spring load of at least five (5) pounds. The ring should be attached to the body of the pin assembly rather than to the end of the release button. If necessary, a spacer must be used so as to position the release head of the pin no deeper than one (1) inch from the outside of the capsule.

10.11 Lift Rings

Each capsule must be equipped with a minimum of four (4) lift

rings (or hook eyes), minimum of 1 ½" inside diameter, located on opposite sides or ends of the capsule. One lift ring must be installed on the top or the very top of the front of the capsule. It must be in sight or visible through an inspection cover . One lift ring must be installed on the top or the very top of the back of the capsule. This top lift ring must have a forty-five (45) degree rope deflector installed on the leading edge of the lift ring. Two lift rings must be installed on each side of the capsule above the boat deck. All lift rings must be attached to the frame rails.

10.12 Locating Device

A Locator Beacon (Pinger) which will transmit an acoustic signal underwater on a frequency of 37.5 KHz must be securely mounted inside each capsule, accessible for testing . Nylon cable ties may not be used for such mounting. The mounting position must be such that the activating end of the Pinger will instantly be covered with water if the capsule sub merges. Pingers will be removed from the capsule for "live" testing at each event. Boat number must be on outside of each unit.

10.13 Mounting

Breakaway capsules must be mounted to the top third (1/3) of the boat's stringers, using a maximum of four (4) grade 2 five sixteenths (S/16) inch bolts and nuts without any washers .

10.14 Paint

The bottom and two (2) inches up the sides and back of the capsule must be yellow . The paint is PPG "Bright Iridescent Yellow" #DAU83034. The Gel coat is Erskin - John Co. "High Hide Yellow" #YG30047YY33 (item #48300474). If you have a yellow capsule and/or boat, you must still conform to the above, and in addition, add a bright red four (4) inch wide cross(+) or X on the bottom of the capsule.

10.15 Pour In Seats

Pour in seats in capsule boats mandat ory.

10.16 Rear Doors

All capsules that have a removable rear door must have the door sealed in accordance with the capsule manufacturer's directions and/or specifications .

10.17 Seat Belts

Seat belt must be a " SFI 16.1" specification approved five, **six**, or seven-point harness commercially manufactured by a recognized safety equipment manu facturer. The shoulder belts must be securely mounted to the roll cage frame rails in accordance with the manufacturer's instructi ons. Absent specific instructions from the manufacturer, the belts should be

secured to the roll cage frame rails approximately four (4) inches below the level of the driver's shoulders, but in no case should they be mounted higher than level with the tops of the driver's shoulders. The crotch strap must go through the seat and anchor to the roll cage frame rails behind the driver's chest line. "PUSH TO RELEASE" latches will not be permitted on any harness. The safety harness must be recertified/dated by the manufacturer **every two (2) years** following date of manufacture. The owner or driver is responsible for ensuring that a new date tag was sewn into the belt after recertification. If boat is involved in an accident, re-cert or replacement **required before tech approval at next event.**

10.18 Side Load Pins

Side load pins, designed to prevent the capsule canopy (or windshield) from shifting to either side in the event of a crash, must be located on each side of the canopy at the latching end. The pins must be a minimum five eighths (5/8) inch chromemoly.

10.19 Exterior Capsule Release

A cable or direct linkage shall be installed securely, one end to be attached to the inside latch release of the capsule lid, the other routed to either the toe, rear, or in the case of direct linkage, the manufacturer's specified location on the outside of the capsule. The end to the outside will have a loop, lever, way to grasp the end of the mechanism that will enable rescue personnel to pull and it will release the capsule lid. The exposed end must be recessed or secured to prohibit the cable from snagging or accidentally releasing, in case of an accident. The exterior location shall be indicated by a "Rescue" decal supplied by SDBA.

Advisory. A tether should be attached from the exterior capsule release bracket to the capsule cage frame.

10.20 Capsule Orientation

Each driver of a capsule equipped boat must, prior to entering his first sanctioned event, demonstrate the ability to use his breathing apparatus. Each driver's equipment will be checked to ensure that it functions properly and that the driver is familiar with its operation. The test requires that a driver go underwater in a swimming pool or at the local race site (subject to approval by the Lead Rescue Diver) with his air tank, regulator, and helmet while under the direct supervision of said diver. The Lead Rescue Diver will also have the authority to determine if the driver demonstrates the ability to properly use his equipment underwater. The Lead Rescue Diver's decision shall be final with regard to all matters relating to underwater safety. Any adverse decision by the Lead Rescue Diver is subject to review by the Board of Directors of KENTUCKY DRAG BOAT ASSOCIATION or the sanctioning division or chapter.

10.21 Capsule Driver Recertification

A driver will be required to have a recertification class with the breathing system no longer than four years on the anniversary of the expiration of their competition driver's license and when changing style of system *or the helmet itself*. The lead rescue diver may choose to recertify the driver by taking the driver to the water either in a pool, or at the race site, and have the driver submerge himself under water, to adequately check the proper operation of the breathing system.

10.22 Clutch and Bell Housing

All boats utilizing a clutch that is bolted to the flywheel must have a SFI approved, aluminum, steel hydro formed or titanium bell housing *and has an SFI sticker*. Boats employing supercharged engines must have a 4130 steel liner, .090 minimum thickness, welded to form a circle the depth of the flat parallel part of the housing. The liner must have the ability to rotate in order to absorb energy in the bell housing. A clutch adjustment slot is acceptable if made to the specification outlined for the slot and 1/4 inch steel cover and attachment. A motor plate must be installed between the engine and bell housing. The plate must be at least 1/4 inch at least 1/8 inch thick steel or 7075T-6 aluminum and cover the entire flanged face of the bell housing, attached on the top 180 degrees to the engine block with at least seven (7) three eighths (3/8) inch high strength steel alloy shouldered studs or 3/8"-24x1-1/8" high strength steel alloy screws (AN 507 - C624 - R18), countersunk one hundred (100) degrees and threaded into the motor plate in six (6) places (between each bolt and/or dowel pin on the upper 180 degrees of the motor plate and five (5) studs. The bottom 180degrees of the housing must be fastened to the motor plate by means of eight 3/8 inch grade 5 or better bolts, washers, and nuts equally spaced below the crankshaft centerline. One inch diameter steel washers must be used on the front side of the motor plate to prevent the nut from pulling through. No more than seven (7) inches will be allowed between the holes. A clutch inspection and maintenance hole may be cut on the back angle of the bell housing . The opening may not exceed eight and one half (8-1/2) inches in length, measured in a straight line, and may not extend forward of the clutch cross shaft. Its end must be fully radius to produce an oval shaped opening. A cover for the inspection hole must be at least one quarter (1/4) inch thick steel and be fastened with at least twelve (12) 3/8 inch grade 8 cap screws. A one quarter (1/4) inch steel fillet must be attached to the inspection cover that fills the hole in the bell housing so that it is flush on the inside of the housing. Welding to repair a bell housing not conforming to this specification is not allowed.

SEE DIAGRAM

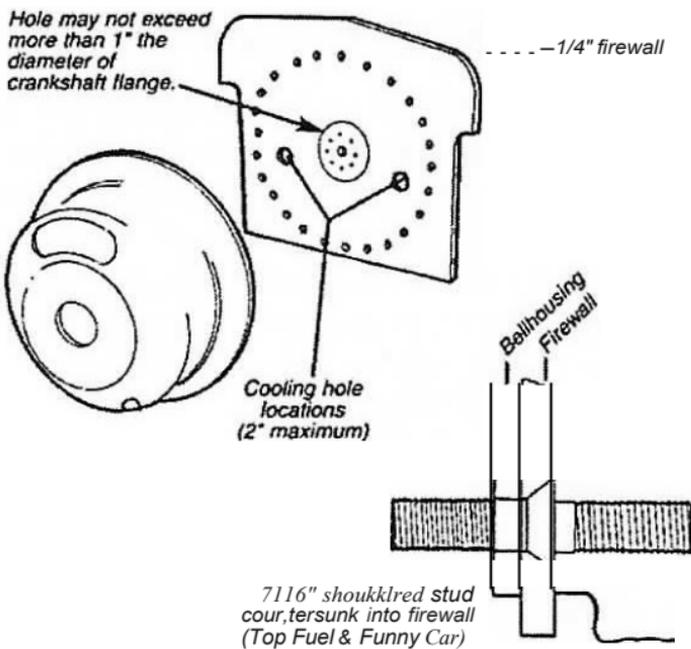

10.23 Parachutes

All Professional class hydro's must have parachutes; TFH will be required to have three (3) and TAH are required to have dual (2) parachutes. TFH will require the 3rd parachute on a separate release lever for third chute deployment. If any chutes are operated by air, in TAH or Pro-Mod, then one mechanical lever will be installed, to operate all chutes at once. Sportsman hydros are not required to have a parachute, but it is recommended. On any boat using nitro-methane as fuel, it is mandatory that the parachute pack and unpack shroud lines be protected with fire-resistant material. Parachutes are subject to deployment during safety inspection. In all classes, each parachute must be mounted with minimum 3/8" grade eight hardware and have a minimum 1" diameter bushing at the shroud attach points.

10.24 Parachutes Release Mechanism

The parachute release mechanism shall be located in such a position as to be readily accessible to the driver. In addition, it is recommended the release mechanism must have the capability of being activated without the driver having to remove either hand from the steering wheel (i.e., a foot operated release pedal or a release activating button on the steering wheel, etc.) Any system that is activated either electrically or by air pressure must have a mechanical override or backup release, either of which must be readily and easily accessible to the driver. If equipped with dual parachutes, the primary release mechanism must release one parachute, and the backup release mechanism must release the second parachute.

10.25 Roll Cage

A capsule roll cage, meeting the advisory requirements listed in SFI spec. 36.3, must have the manufacturer's name, serial number and date of manufacture. Plating is prohibited, painting

and powder coating allowed. Cages must be sonic tested by a qualified sonic testing inspector (KDBA, and refer to KDBA for acceptance of other associations certifications, every three years and have dated stickers issued by that Inspecting authority.

10.26 Windshield

The windshield shall be attached and sealed (between edges) to the canopy shell with adhesive/sealant that is designed to seal windshield to canopy. Mount screws must be at the apex of all corners. See *Appendix H* for details. Note: try to plan the reattaching of the windshield and replacement of the "J" type capsule latches at the same time.

N

Appendix A

Definitions & Terms

Alternate Boat - The boat(s) with the lowest legitimate E.T. which failed to qualify into a class field. This boat(s) is eligible for insertion into the eliminations program as described in "Eliminations/Ramp Call/ Launch."

ADBA- Arizona Drag Boat Association.

Blown - Supercharged.

Breakout - A term indicating that a bracket format class boat has run an E.T. that is quicker than is allowed in its particular class.

CDBA- Columbia Drag Boat Association.

Crew Member - Any person, or persons, who attend a sanctioned event to directly or indirectly support, help with, or work on a race boat which has been registered for competition at said event.

DOT - U.S. Department of Transportation.

Driver - Any person, or persons, who registers at a sanctioned event to drive, as well as have full operational control of the race boat while in competition at said event. Although driver is singular in context, when used with in this rule book, the term driver shall be considered to mean each driver individually when more than one driver is registered to drive a single boat.

E.T. - Elapsed time (the length of time that it requires a boat to travel from the starting line to the finish line as measured in thousandths of a second).

Eliminated (elimination) - The boat is prohibited from further competition, unless reinstated into the racing program pursuant to the break rule.

Eliminations - A single elimination tournament wherein competitors are matched up in competing brackets. Each winner goes out to the next bracket on the tournament chart, and runs the winner of the pairing below him, unless a bye run is awarded. This continues until one winner remains.

Event - The time between the commencement of track set up at the event site until the event site is closed and secured following the conclusion of eliminations.

FAA- U.S. Federal Aviation Administration .

Failure to Prove Capability - A term indicating that an E.T. format class boat has run an E.T. which is slower than the minimum for the class.

Flat (flat bottom) - A type of boat hull, the bottom of which is relatively flat with a minimum length of sixteen feet, with no horizontal breaks.

Foul (foul start) - The boat has broken the beam of the starting line light sensor prior to receiving a solid green light.

Hydro (hydroplane) - A conventional type of boat hull designed with a tunnel between the front sponsors for the purpose of trapping air and lifting the bottom of the hull to ride all or in part above the surface of the water.

Jet (jet boat) - A type of boat hull, which in lieu of a propeller, uses a propulsion system which pumps water under extreme pressure and expels it through a nozzle at the rear of the boat.

KDBA- Kentucky Drag Boat Association .

M.P.H. - Miles per hour (the speed attained by the boat in the quarter mile course) as measured in the speed traps at the end of the race course.

Med I Tag - Medical ID Tag containing driver's personal and medical information , including but not limited to: allergies, blood type, medications, and emergency contact.

Member Division/Chapter - Any drag boat racing association which has formally adopted and agreed to adhere to the rules, regulations, conditions, and other provisions contained herein this RACING RULES AND SAFETY REQUIREMENTS booklet and uses same to sanction and conduct drag boat races accordingly.

Own Power - When used to define forward motion of a boat, own power shall mean movement powered only by the boat's internal combustion engine. It specifically excludes, but is not limited to, battery powered starting motor, paddling or other means of propulsion by the driver, or wind and water currents. It does not, however, exclude the coasting which results from the original motion that had been generated by the internal combustion engine of the boat.

Owner - Any individual , person, group, club, corporation, association, part n ership, or other entity which actually owns or holds title to a race boat which is registered for competition at any sanctioned event. Although owner is singular in context, when used within this rulebook, the term owner shall be considered to include any or all of the individuals, persons, groups, clubs, corporations, associations, part nerships, or other entities, either individually or collectively, which own said boat.

Outboard - any boat that has its engine mounted on the transom.

Participant - Each owner, driver, or individual crew member of any boat which has been officially registered for competition at any sanctioned event.

Pro Racer – A racer who participates in any Professional category and races the entire circuit in pursuit of the Championship Series Points.

Promoter (event promoter; race promoter) – Any individual, person, group, club, corporation, association, partnership, or other entity with whom the KENTUCKY DRAG BOAT ASSOCIATION, or one of its sanctioning divisions or chapters has executed either a verbal or written race agreement.

Propeller – A device used to propel flat and hydro hulls through the water.

Race Director – The individual responsible for the overall flow and operation of the race; calls classes as needed;

Red Light – Course is closed **for** safety reasons. Boats must come to an immediate stop.

Rudder – A mechanical device extending into the water (to at least the bottom tip of the propeller) which is used to steer the boat.

Safety Inspector – The individual(s) who performs safety/technical inspections of each boat prior to its being allowed to register; resolves technical questions; performs fuel checks as needed or requested.

Safety Pass – A single lane pass which is intended to determine the safety of the boat and/or driver for further participation. E.T.s and M.P.H. are not provided to any participant on a safety pass.

Sanction Supervisor – The ultimate authority at a sanctioned event; interprets rules; oversees safety inspections and fuel checks; receives, evaluates, and responds to any protests.

Sanctioning Division/Chapter – The individual member division or chapter which sanctions a specific event and assumes full responsibility for the conduct of said event as well as the enforcement at said event of all rules, regulations, conditions, and provisions contained herein.

Sponsor (event sponsor; race sponsor) – Any individual, person, group, club, corporation, association, partnership, or other entity who has contractually or otherwise agreed with THE KENTUCKY DRAG BOAT ASSOCIATION or one of its sanctioning divisions or chapters, or the event promoter to contribute financially to the production of a sanctioned event. The sponsor may or may not be the same individual person, group, etc. as the promoter.

Starter – The official responsible for starting all of the boats;

ensures that no boat violates any safety rules or procedural rules while in the area of the starting line.

Timing Official - The official responsible for the proper operation of the timing equipment; observes and records all elapsed times and speeds; furnishes E.T. and M.P.H.

Unblown - Naturally aspirated; either carbureted or fuel.

0

n

n

n

Appendix B
KENTUCKY DRAG BOAT ASSOCIATION

Member Associations

ADBA

Arizona Drag Boat Association
www.adbaracing.com
Jeremy Denny, President

CDBA

Columbia Drag Boat Association
www.cdbaracing.com
Doug Young, Commodore

KDBA

Kentucky Drag Boat Association
www.kdba.net
Barry Salsman, President

SDBA

Southern Drag Boat Association, LLC
David Carroll, owner

Appendix C

Fees and Fines

The following fees are standard among all the KENTUCKY DRAG BOAT ASSOCIATION divisions or chapters. The fines are the maximum amounts which may be assessed against any competitor by the Board of Directors. If any fees and/or fines have been levied against any participant by any one of the KENTUCKY DRAG BOAT ASSOCIATION divisions or chapters, said participant will not be allowed to compete at any other the KENTUCKY DRAG BOAT ASSOCIATION division or chapter event until such time as all fees and/or fines have been satisfied. All fees and fines shown herein must be Paid by cash in U.S. funds (NO CHECKS ACCEPTED).

Protest Fees

Protest Fee for Illegal Equipment.....	\$ 50.00
Protest Fee for Engine Tear Down.....	\$ 350.00
Protest Fee for Fuel Check (with meter)	\$ 50.00
Protest Fee for Fuel Check (chemical analysis).....	\$ 150.00
Protest Fee for Water Check	\$ 25.00
Compensation for Engine Tear Down	\$ 50.00

Returned Check Fees

Handling Fee for Returned Check (Per check)	\$ 50.00
Handling Fee for Stop Payment (per check).....	\$ 100.00
Handling Fee for Account Closed (per check)	\$ 150.00

Refusal to Allow Engine Tear Down	\$ 2,000.00
Refusal to Give Fuel or Fluid Samples	\$ 2,000.00
(Gasoline, Alcohol, Nitro-methane, Water, or Oil)	

Failure to clear course max 100 pts max	\$250.00
---	----------

Illegal or Oversized Engine	\$ 2,000.00
Illegal Fuel or Fluids	\$ 2,000.00
Violation of Substance Abuse Policy	\$ 3,000.00
Submission of Fraudulent Physical.....	\$ 500.00
Damage to Association Equipment.....	Cost
Unsportsmanlike Conduct.....	\$ 2,000.00
Abusive language.....	\$ 2,000.00
Obscene Gestures	\$ 2,000.00
Physical Assault	\$ 3,000.00
Willful Disruption of Racing Program.....	\$ 2,000.00

Any action which could result in disqualification (as defined under Grounds for Disqualification)	\$ 2,000.00
--	-------------

Any actions, expressions, or displays detrimental to drag boat racing which are not specified above	\$ 3,000.00
---	-------------

Appendix D
Sportsman and Bracket Division
and Championship

Eligibility – Must be a current member of KDBA. Points for the Division races **will** start accumulating upon joining KDBA. Note: Prior membership with one of the other member group no longer required to participate.

Division Championship – There are three Divisions and each Division will consist of events identified by KDBA. The champion being the boat with the most points accumulated. Boats may compete in more than one Division.

Appendix F

Capsule Latch Specs

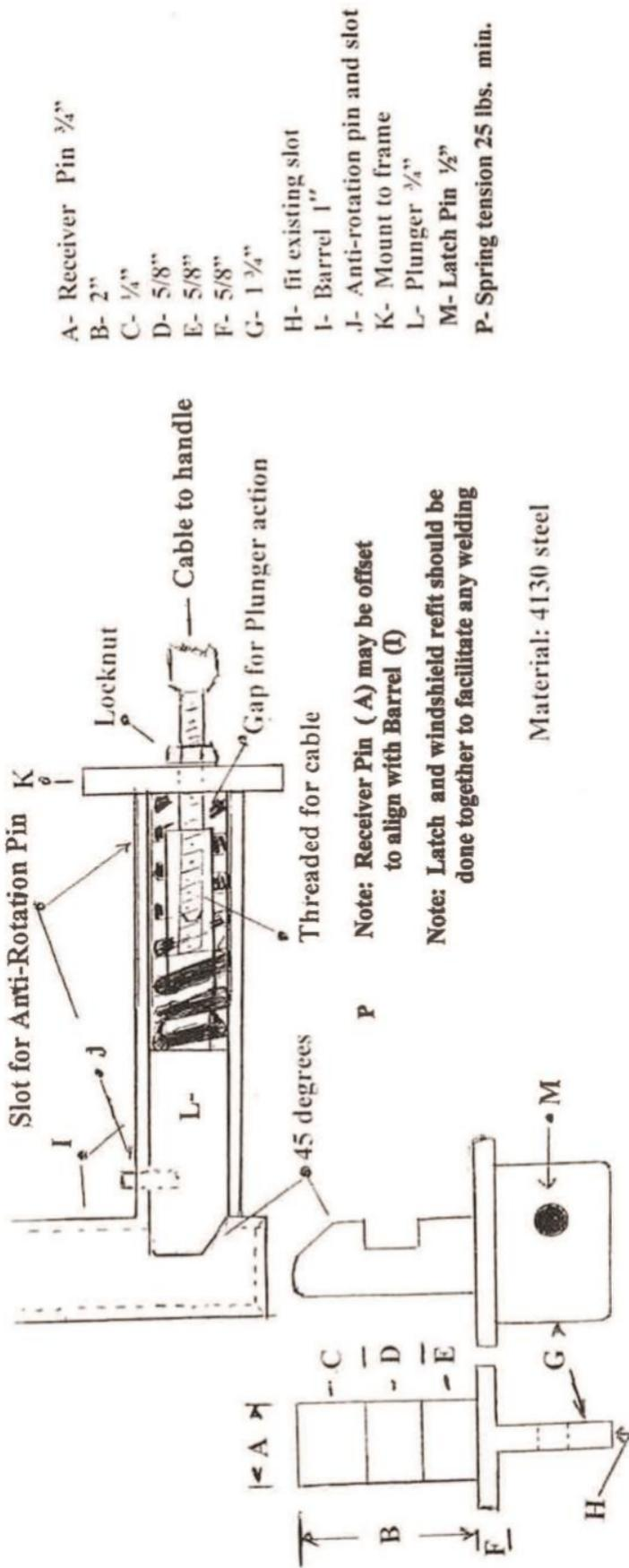

APPENDIX G

RUDDER CLAMSHELL SPECS

Clamshell Minimum Specifications

Notes:

- All measurements are minimum requirements.
- Only left side of Clamshell shown - need to duplicate right side.

Hardware:

Grade 8

Clam Pin:

Aquamet 21 with bronze oil light bushing.

Materials:

Aluminum - 6061-T6

Stainless - 316

Measurements: (Minimum)

Twin Prop		Single Prop	
Aluminum	Stainless	Pro	Sportsman Aluminum
A- 1 1/2"	1"	1"	3/4"
B - 8 1/2"	7 1/2"	6"	6"
C - 5 3/4"	5 1/4"	5"	5"
D - 1 1/2"	1"	3/4"	5/8"
E - 3/4"	3/4"	3/4"	5/8"
F - 4 1/2"	4 1/2"	4 1/2"	4 1/2"
G - 3/4"	1/4"	5/8"	1/2"
H - equal distance to centerline of clam pin (Min 3/4")			
I - Center line between end of rudder cavity and edge of clam shell			
J - 1 1/4"	1 1/4"	1"	3/4"

Upper and Lower Mounts:

K - Mfg's Specs

L - Mfg's Specs

M - 1 1/4" 1 1/4" 1" 3/4"

N - Same as diameter of J (clam pin)

Tiller:

Length and width- per mfg's specs

O - 1" 3/4" 3/4" 5/8"

P - 1 1/4" 3/4" 1" 3/4"

Support Rod(s):

Two required for twin prop.

Note: Lighting holes not allowed on twin props.

Rudder(min. thickness):

' TFHand TwinProp 3/4"

Single Prop Pro Class 5/8"

Sportsman Class 1/2"

APPENDIX G

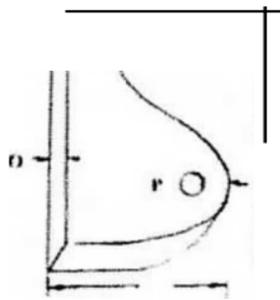
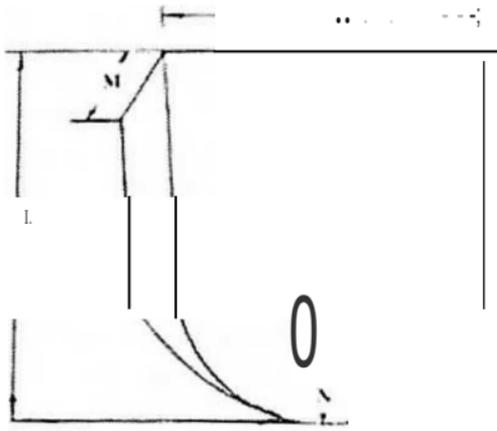
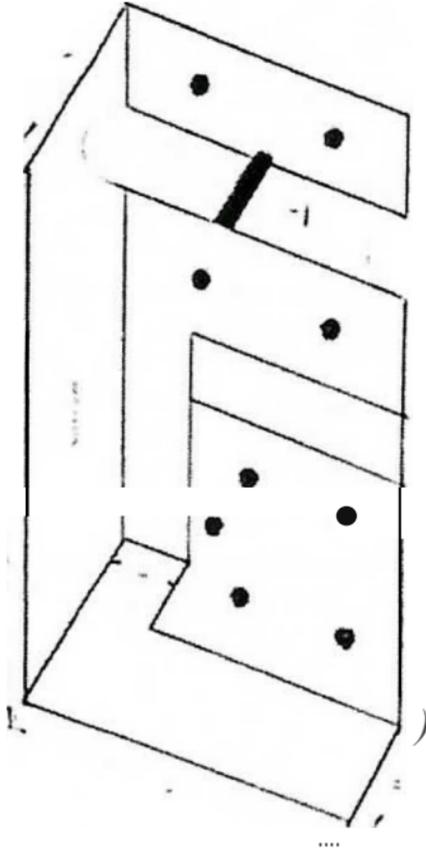

APPENDIX H
WINDSHIELD ATTACHMENT SPECS

Windshield Attach Specs

Note: Windshield and latch refit should be done together to facilitate any welding

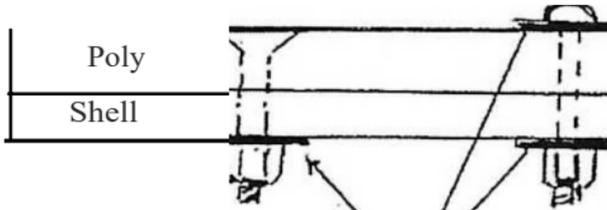

Stainless steel fender washers
used to spread load

Add mount screws at
the apex of all corners

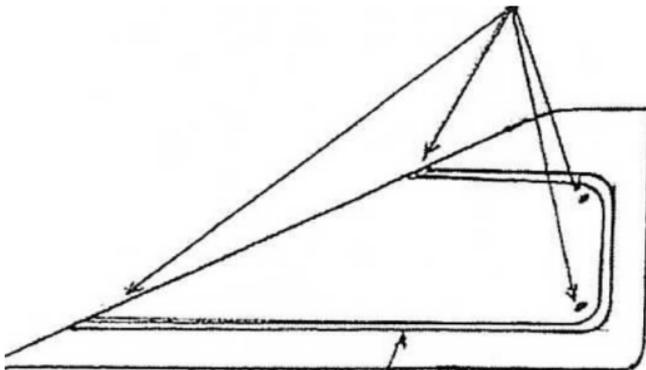

Mount and seal windshield
using 3M 4200 adhesive or
equivalent

(CAUTION : some adhesives
contain chemicals harmful to
acrylic and poly plastics)

APPDENDIX I
CAPSULE ALIGNMENT PINS

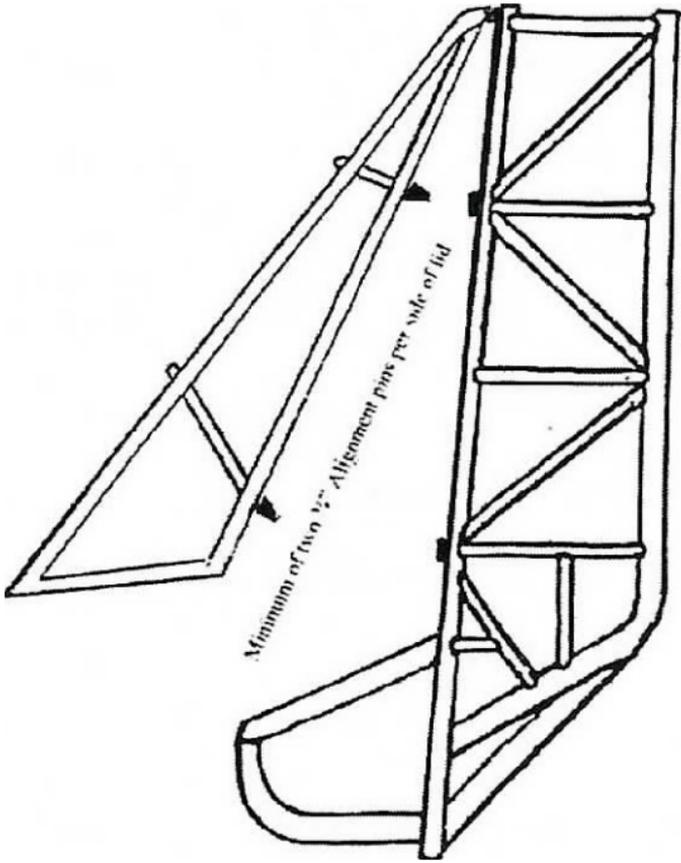

APPENDIX J
SFI SPECS & RECERT. REPORTS

SFI Specs and Other Recertification Periods

<u>SFI Spec Number</u>	<u>Recert Period</u>
3.1 Gloves	N/A
3.3 Neck Collar	N/A
6.2/6.3 Clutch Cans	2 yrs
14.1.2.3 .21Blower Restraint Pro:	2yrs (except PM/PO) All others: 4 yrs
16.1 Seat Belts	2 yrs
23.1 Blower Burst Panels	N/A
31.1 Flame Resistant Helmets	12 yrs
36.1 Capsule Shells	2 yrs
36.2 Capsule Windshields	2 yrs
36.3 Capsule Roll Cages(sonic test)	3 yrs
38.1 Head/Neck Restraints(HansType)	5 yrs
41.1 Helmets	12 yrs
45.1 Roll Cage Padding	N/A
Capsule Air Systems:	
Tanks: VIP	Annually
DOT	5 yrs
Stage 1 & 2 Regulator	2 yrs
Drivers License	2 yrs
LifeJackets:	
Chute Type	2 yrs
Non Chute	3yrs
DOT	N/A

INDEX

A

Accidents	19
Accident Report	19
Advertising on Boats	7
Air Supply - Capsule	71
Age Requirements	26
Assumption of Risk	4

B

Ballistic Shorts	68
Battery Disconnect Switch	61
Bell Housing - Clutch	77
Bilge Pump	57
Blast Plate	59
Blower	14, 15, 59
Blower Burst Panel	59
Blower Restraints	59
Boat Number	22, 60
Bow Eye	60
Breakaway s- Capsule	71, 73
Breakout - Qualifying	33
Breakout- Eliminations	50

C

Capsules	71
Capsule Driver Recert ifi cati on	77
Capsule Orientation	76
Cavitation Plate	59
Championship Series Points	21
Chrome Plating	61, 66
ClassCapability	30
ClassChanges	34
Class Structure - Profe ssional	14
Class Stru ct ure - Sportsman	14
Class Win - Single Boat	50
ClassWinner s	SO
Compliance of Rules	5
Conduct and Action of Participants	8
Correspondence	12

D

Decals, (On Boat)	61
Definitions	80
Disclaimer	2
Disqualifi cati on, Grounds For	51
Drive Line Cover	61
Drive Line Loop	62
Driving to the Holding Rope	19
Driver's License - Class Requireme nt	26
Age Requirem ent	26

Class Restriction.....	27
Duration of License	27
Physical	27
Renewal.....	28
Suspension/Revocation.....	28
Test.....	28
Upgrade	27
Visual Aid	27
Driver's Meeting.....	26
Driver's Suit.....	69

E

Elimination of Classes	16
Eliminations	35
Breakout.....	50
Class Win - Single Boat	50
Class Winners	50
Driver Limitation - One Boat.....	49
First or Worst.....	52
Foul Start.....	50
Grounds for Disqualification	51
Grounds for Elimination	35, 50
Identical E.T.s.....	50
Ladder System	37
Lane Selection.....	49
Order of Eliminations	49
Ramp Call/Launch.....	49
Removal of Rudders and Drain Plugs	20
Starting Motors on Launch Ramp.....	20
Stopping on Course	20
Engagement Device	62
Entry Fees.....	30
Ethanol as Fuel.....	17
Excessive ET - Open Boats.....	19
Exterior Capsule Release	76
Exhibition Pass	30
Eye Protection	69

F

Failure to Drive Off Course	20
Fines.....	85
Fire Control - Capsule	73
Fire Extinguisher	62
First or Worst	52
Flotation Capsule	73
Flotation - Hull.	73
Flywheel Cover.....	62
Foreword	2
Foul Start.....	50
Foul Start-Record Runs.....	9
Fuel Injection	15
Fuel, Racing	17
Fuel Samples.....	17
Fuel Shut-off Valve.....	63

G

Gasoline as Fuel	17
General Provisions	3
General Safety Requirements	57
Goggles	69
Gloves	69
Grounds for Disqualification	51
Grounds for Elimination	50

H

Hans Type Device	68
Harmonic Balancer	63
Helmet	68
Helmet Restraints	68
Holding Rope	31
Holding Rope Deflector	63

n

Impeller	63
Impeller Release Mechanism	64
Incomplete Qualifying	34
Incomplete Race	24
Installation of Rudders and Drain Plugs	19
Interior- Capsule	74

K

Kill Switch	64
-------------------	----

L

Ladders - Pairing	37
Lane Selection	49
Latches - Capsules	74
Latch Pins - Capsule	74
Layout of Race Course	84
Life Jacket	70
Lift Rings - Capsule	74
Locating Device - Capsule	75

M

Med I Tag	26
Membership	11
Annual Racing	11
Associate	11
Renewals	11
Single Event	12
Merchandise, Sale of	8
Methanol as Fuel	17
Mounting of Capsules	75
Multiple Drivers/One Boat	30

N

Neck Collar-Capsule	68
New Boats	20
Nitro-methane as Fuel.....	17
Nitrous Oxide.....	14
Number- Boat	22, 60
Number- Tow Vehicle, Boat Trailer	60

O

Official Error - Points	24
Official Error - Qualifying	34
Oil Additives	17
Optional Classes	16
Ownership at an Event.	30

P

Paddle	64
Pain t - Capsule Bottom.....	75
Pairing for Elimination s.....	35
Pairing Ladders.....	37
Parachut e	78
Parachute Release Mechanism.....	78
Patch, (Driving Suit).....	70
Payments.....	12
Physical	27
Pinger - Capsule	75
Pit Spaces.....	16
Points - Championship Series	21
Boat Number	22
Duration of Series	22
Eligibility.....	22
Membership Requirement.....	22
Participation - 51% Rule	22
Points, Incomplete Race	24
Point s, Official Record	24
Points, Qualifying.....	23
Points, Qualifying Position	23
Points, Registration	23
Points, Retention of.....	24
Points, Round Winner	24
Series Winners	24
Tie Breaking	25
Pour In Seats - Capsules	75
PressureRelief Valve	64
Problems	54
Propeller	64
Prope ller Shaft	65
Propeller Shaft Release.....	65
Propylene Oxide	15
Protest	54
Protest Fees	85
Publicity	7
Pump Loader.....	66

U

Q

Qualifying	33
660'/1000'	35
Qualifying Attempt	33
Qualifying Attempt Voided	33
Qualifying Incomplete	34
Qualifying Canceled	34
Breakout	33
Class Changes	34
Failure to Prove Capability	33
Foul Start	33
Identical E.T.s	33
Number of Qualifiers	33

R

Race Director	82
Racing Classes	14
Bracket Class Structure	15
Professional Class Structure	14
Sportsman Class Structure	15
Elimination of Classes	16
Optional Classes	15
Radio Receivers	65
Ramp Call/Launch	49
Reaction Timers	31
Records	9
Approval	9
Cubic Inch Check	9
Disqualified Boat	9
Establishing	9
Foul Start	9
Fuel Samples	9
Membership Requirement	8
Multiple Records	9
Registration	29
Class Capability	30
Competition License	26
Membership Requirement	11
Multiple Drivers	30
One Boat/One Class	30
Safety Inspection	23
Suspensions	28
Registration Closed	30
Removal of Rudders and Drain Plugs	20
Retention of Boats and Parts	55
Returned Checks	12, 85
Roll Cage - Capsule	78
Roll Cage Padding (Interior)	74
Rope Deflector	63
Rudders	65
Rudder Clamshell	66
Rudders, Installation and Removal	20

S

Safety Chain-Trailer	66
Safety Collar	66
Safety Equipment- Capsule	71
Safety Inspector	82
Safety Pass.....	30
Sale of Merchandise.....	8
Samples, Fuel.....	17
Seat Belt - Capsule	75
Side Pin - Capsule	76
Single Run.....	50
Smoking in Boats	20
Starter	83
Starting Clock	31
Starting Clock Light Definitions	31
Starting of Motors.....	20
Starting Procedures	31
Starting Sequence - SDBA/CDBA	32
Starting Sequence -ADBA/KDBA	32
Steering	66
Stop Payment on Checks	86
Stopping on Course.....	20
Substance Abuse Policy.....	6
Supercharger	59
Supercharger Burst Panel.....	59
Supercharger Restraints	59
Suspensions.....	30

T

Table of Contents	1
Terms	80
Throttle.....	67
Throttle Return Spring.....	67
Throttle Stop	67
Time slips	31
Tow Vehicle Boat Numbers.....	60

V

Visual Aid.....	69
Visual Aid on Competition Driver's License.....	69

W

Waiver of Compliance.....	6
Water Injection.....	15
Water Safety	19
Whirl-a-Ways	66
Windshield - Capsule	7